



EMC Test Report

Report Number: UCSCE-1810-0075

Applicant

Kobol Innovations Pte. Ltd.
101 Cecil Street #26-01/07 Tong Eng Building Singapore 069533

Manufacturer

Kobol Innovations Pte. Ltd.
101 Cecil Street #26-01/07 Tong Eng Building Singapore 069533

Test information

Test product: **Helios4**
Test model name: **Helios4 2GB ECC**
Received number: **UCS-R-2018-1233**
Test date: **2018.09.26 ~ 2018.09.27**
Issued Date: **2018.10.08**

Test standards

EN 55032:2015
EN 61000-3-2:2014
EN 61000-3-3:2013
E EN 55024:2010

The results shown in this test report refer only to the sample(s) tested unless otherwise stated.
This Test Report cannot be reproduced, except in full.

Tested by: J.W. Im

Approved by: I.Y. Jeong

Product information

Division	Main Specifications and Characteristics
CPU Model	Marvell Armada 388 (88F6828), ARM Cortex-A9
CPU Architecture	ARMv7 32 bit
CPU Frequency	Dual Core 1.6 GHz
Additional Features	RAID Acceleration Engines, Security Acceleration Engines, Wake-on-LAN
System Memory	2 GB DDR3L ECC
SATA 3.0 Ports	4
Max Raw Capacity	48 TB (12 TB drive x 4)
GbE LAN Port	1
USB 3.0	2
microSD (SDIO 3.0)	1
GPIO	12
I2C	1
UART	1 (via onboard Micro-USB converter)
Boot Mode Selector	SPI, SD Card, UART, SATA
SPI NOR Flash	32 Mbit onboard
PWM FAN	2
DC input	12 V / 8 A

Specifications: Refer to the manual

Contents

1. Testing laboratory.....	5
1.1 Location.....	5
2. Test Configuration and Condition	6
2.1 EUT operating condition	6
2.2 EUT test configuration diagram	6
2.3 Peripheral equipments list for test	6
2.4 Cable connections	7
2.5 Information of the instruction for class A ITE.....	7
2.6 EUT modifications	7
3. Summary of Test Results.....	8
3.1 Summary of test results	8
3.2 Performance of criteria	8
4. Test Results	9
4.1 Conducted disturbance	9
4.2 Radiated disturbance (below 1 GHz)	16
4.3 Radiated disturbance (above 1 GHz).....	18
4.4 Harmonics current emissions	22
4.5 Voltage changes, Voltage fluctuations and flicker	30
4.6 Electrostatic discharge.....	31
4.7 Radiated RF electromagnetic field immunity.....	33
4.8 Electric fast transient/burst immunity	36
4.9 Surge immunity	38
4.10 Conducted disturbance induced by RF fields immunity.....	40
4.11 Voltage dips and short interruptions	42
5. EUT Photos	44
5.1 Test Setup Photographs	44
5.1.1 Conducted disturbance (AC mains power ports).....	44
5.1.2 Conducted disturbance (Asymmetric mode)	45
5.1.3 Radiated disturbance (below 1 GHz)	46
5.1.4 Radiated disturbance (above 1 GHz).....	47
5.1.5 Harmonics current emissions	48
5.1.6 Voltage changes, Voltage fluctuations and flicker	48



5.1.7 Electrostatic discharge.....49

5.1.8 Radiated RF electromagnetic field immunity.....49

5.1.9 Electric fast transient/burst immunity.....50

5.1.10 Surge immunity50

5.1.11 Conducted disturbance induced by RF fields immunity.....51

5.1.12 Voltage dips and short interruptions51

5.2 External Photographs of EUT52

Revision History

Issued Report No.	Issued Date	Revisions	Effect Section
UCSCE-1810-0075	08-Oct-2018	Initial Issue	All

This report shall not be reproduced except in full, without the written approval of UCS Co., Ltd.

This document may be altered or revised by UCS Co., Ltd. personnel only, and shall be noted in the revision section of the document.

Any alteration of this document not carried out by UCS Co., Ltd. will constitute fraud and shall nullify the document.

1. Testing laboratory

1.1 Location

UCS Co., Ltd.

Office: #702, 268, Hagui-ro, Dongan-gu, Anyang-si, Gyeonggi-do, 14056, KOREA.

Tel: +82-1833-5681

Fax: +82-31-420-5685



EMC Center: 161-8, Ansandong-gil, Hwaseong-si, Gyeonggi-do, Korea

EMC Test Site: 35-13, Hwalcho-gil, 109beon-gil, Hwaseong-si, Gyeonggi-do, 18278, Korea

Tel: +82-1833-5681

Fax: +82-31-355-5848

Laboratory Accreditations and Listings

Country	Agency	Registration Number	Logo
USA	FCC	803225	
KOREA	RRA	KR0045	
KOREA	KOLAS	KT263	
CE	CE	-	

2. Test Configuration and Condition

2.1 EUT operating condition

- After connecting EUT and peripherals, the EUT was observed under controlled conditions using the PuTTY program continuously during the test
- A software test suite, provided by manufacturer, was running on the EUT to exercise all high speed interfaces.

- Input power condition during the measurements was 230 V~, 50 Hz.

2.2 EUT test configuration diagram

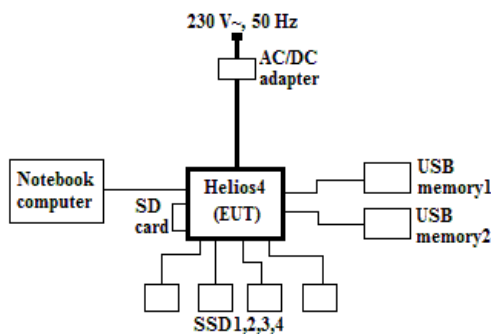

2.3 Peripheral equipments list for test

Equipment Name	Model	Serial Number	Manufacturer
Helios4 (EUT)	Helios4 2GB ECC	-	Kobol Innovations Pte. Ltd.
AC/DC adapter	M120400P911	-	MOST Optoelectronics International Limited
SSD 1	WDS120G2G0A-00JH30	-	Western Digital Corporation
SSD 2	WDS120G2G0A-00JH30	-	Western Digital Corporation
SSD 3	WDS120G2G0A-00JH30	-	Western Digital Corporation
SSD 4	WDS120G2G0A-00JH30	-	Western Digital Corporation
USB memory1 (8 GB)	SDCZ73-032G	-	SanDisk
USB memory2 (8 GB)	SDCZ73-032G	-	SanDisk
SD card (16 GB)	SDDSDQAD-016G	-	San Disk
Notebook computer	6570b	-	H.P

2.4 Cable connections

Start		End		Cable	
Name	I/O Port	Name	I/O Port	Length (m)	Specs
Helios4 (EUT)	SATA 1,2,3,4	SSD 1,2,3,4	SATA Data 1,2,3,4	0.6	Shielded
	MOLEX port1,2	SSD 1,2,3,4	SATA Power 1,2,3,4	0.6	Shielded
	SD slot	SD card	-	-	-
	USB port1,2	USB memory1,2	USB1,2	0.6	Shielded
	DC in	AC/DC adapter	DC out	1.6	Unshielded
	LAN	Notebook computer	LAN	3.0	Unshielded

2.5 Information of the instruction for class A ITE

- Class A equipment shall have the following warning in the instructions for use, to inform the user of the risk of operating this equipment in a residential environment:

WARNING

This equipment is compliant with Class A of CISPR 32.
In a residential environment this equipment may cause radio interference.

2.6 EUT modifications

- None

3. Summary of Test Results

3.1 Summary of test results

Standard	Test Item	Results
EN 55032:2015	Conducted emissions at the AC mains power ports	Met Class A / Pass
	Asymmetric mode conducted emissions	Met Class A / Pass
	Conducted differential voltage emissions	N/A (See Note 1)
	Radiated emissions	Met Class A / Pass
EN 61000-3-2:2014	Harmonics current emissions	Met / Pass
EN 61000-3-3:2013	Voltage changes, Voltage fluctuations and flicker	Met / Pass
EN 55024:2010	Electrostatic discharge	A Met by Criterion / Pass
	Radiated RF electromagnetic field immunity	A Met by Criterion / Pass
	Electrical fast transient/burst immunity	A Met by Criterion / Pass
	Surge immunity	A Met by Criterion / Pass
	Conducted disturbance induced by RF fields immunity	A Met by Criterion / Pass
	Magnetic field immunity	N/A (See Note 2)
	Voltage dips and short interruptions	A and C Met by Criterion / Pass

* Note 1: This test is not performed because the EUT is does not have TV/FM broadcast receiver tuner ports and RF modulator output ports.

* Note 2: The EUT does not contain devices susceptible to magnetic fields, so the test was not performed.

3.2 Performance of criteria

Performance criterion A

During and after the test the EUT shall continue to operate as intended without operator intervention. No degradation of performance or loss of function is allowed below a minimum performance level specified by the manufacturer when the EUT is used as intended. The performance level may be replaced by a permissible loss of performance. If the minimum performance level or the permissible performance loss is not specified by the manufacturer, then either of these may be derived from the product description and documentation, and by what the user may reasonably expect from the EUT if used as intended.

Performance criterion B

After the test, the EUT shall continue to operate as intended without operator intervention. No degradation of performance or loss of function is allowed, after the application of the phenomena below a performance level specified by the manufacturer, when the EUT is used as intended. The performance level may be replaced by a permissible loss of performance. During the test, degradation of performance is allowed. However, no change of operating state or stored data is allowed to persist after the test. If the minimum performance level (or the permissible performance loss) is not specified by the manufacturer, then either of these may be derived from the product description and documentation, and by what the user may reasonably expect from the EUT if used as intended.

Performance criterion C

During and after testing, a temporary loss of function is allowed, provided the function is selfrecoverable, or can be restored by the operation of the controls or cycling of the power to the EUT by the user in accordance with the manufacturer's instructions. Functions, and/or information stored in non-volatile memory, or protected by a battery backup, shall not be lost.

4. Test Results

4.1 Conducted disturbance

Test Standard	EN 55032:2015, Class A		
Test venue	Shield Room 2		
Tested Date	2018.09.26		
Input Ratings	230 V~, 50 Hz		
Temperature	(22.5 ± 0.1) °C	Humidity	(49.7 ± 0.1) % R.H.
Test result	Met Class A / Pass		

4.1.1 Limit

AC mains power ports

Frequency range [MHz]	Coupling device	Detector type / bandwidth	Class A limits [dB μ V]
0.15 ~ 0.5	AMN	Quasi Peak / 9 kHz	79
0.5 ~ 30			73
0.15 ~ 0.5	AMN	Average / 9 kHz	66
0.5 ~ 30			60

Frequency range [MHz]	Coupling device	Detector type / bandwidth	Class B limits [dB μ V]
0.15 ~ 0.5	AMN	Quasi Peak / 9 kHz	66 ~ 56
0.5 ~ 5			56
5 ~ 30			60
0.15 ~ 0.5	AMN	Average / 9 kHz	56 ~ 46
0.5 ~ 5			46
5 ~ 30			50

Asymmetric mode

Frequency range [MHz]	Coupling device	Detector type / bandwidth	Class A voltage limits [dB μ V]
0.15 ~ 0.5	AAN	Quasi Peak / 9 kHz	97 ~ 87*
0.5 ~ 30			87
0.15 ~ 0.5	AAN	Average / 9 kHz	84 ~ 74*
0.5 ~ 30			74

Frequency range [MHz]	Coupling device	Detector type / bandwidth	Class B voltage limits [dB μ V]
0.15 ~ 0.5	AAN	Quasi Peak / 9 kHz	84 ~ 74
0.5 ~ 30			74
0.15 ~ 0.5	AAN	Average / 9 kHz	74 ~ 64
0.5 ~ 30			64

* The limit decreases linearly with the logarithm of frequency.

4.1.2 Test set-up and procedure

The mains terminal disturbance voltage was measured with the equipment under test (EUT) in a shield room.

The EUT was connected to an artificial mains network (LISN) placed on the floor.

The EUT was placed on non-metallic table 0.8 m above the metallic, grounded floor.

Amplitude measurements were performed with a quasi-peak detector and an average detector.

Conducted emission, Telecom port : 1.8 dB

The measurement uncertainty is given with a confidence of 95 % with the coverage factor, $k = 2$.

4.1.3 Test equipment used

Equipment	Model	Serial No.	Vendor	Next Cal. Date	Use
Test Receiver	ESPI3	101171	ROHDE & SCHWARZ	2019.08.03	<input type="checkbox"/>
Test Receiver	ESR7	101120	ROHDE & SCHWARZ	2019.08.03	<input checked="" type="checkbox"/>
LISN	NSLK 8127	8127518	SCHWARZBECK	2019.08.03	<input type="checkbox"/>
Two-Line V-Network	ENV216	3560.6550.12-101874-Rq	ROHDE & SCHWARZ	2019.08.03	<input type="checkbox"/>
Two-Line V-Network	ENV216	3560.6550.12-102073-Ax	ROHDE & SCHWARZ	2019.08.03	<input checked="" type="checkbox"/>
Four-Line V-Network	ENV432	101284	ROHDE & SCHWARZ	2019.08.03	<input type="checkbox"/>
EMI Receiver	9010	274WX90601	PMM	2019.08.03	<input type="checkbox"/>
ISN	ISN T800	30813	TESEQ	2019.02.06	<input checked="" type="checkbox"/>
ISN	ISN T8-Cat6	29709	TESEQ	2019.02.06	<input type="checkbox"/>
PULSE LIMITER	ESH3-Z2	100059	ROHDE & SCHWARZ	2019.02.01	<input type="checkbox"/>
ARTIFICIAL MAINS NETWORK	L3-32	1220X20311	PMM	-	<input type="checkbox"/>



4.1.4 Test data (AC mains power ports)

- Frequency range : 150 kHz ~ 30 MHz
- Bandwidth : 9 kHz

[Quasi-Peak]

Frequency [MHz]	LISN [dB]	Cable Loss [dB]	Line [H/N]	Limit [dB μ V]	Reading [dB μ V]	Results [dB μ V]	Margin [dB]
0.31	9.68	0.01	N	79.00	51.87	61.56	-17.44
0.56	9.84	0.02	H	73.00	49.82	59.68	-13.32
0.62	9.80	0.02	N	73.00	51.27	61.09	-11.91
0.68	9.78	0.02	N	73.00	51.25	61.05	-11.95

[Average]

Frequency [MHz]	LISN [dB]	Cable Loss [dB]	Line [H/N]	Limit [dB μ V]	Reading [dB μ V]	Results [dB μ V]	Margin [dB]
0.56	9.84	0.02	H	60.00	44.75	54.61	-5.39
0.62	9.80	0.02	N	60.00	45.95	55.77	-4.23
0.68	9.78	0.02	N	60.00	45.03	54.83	-5.17

* Remark: "H" Hot Line, "N" Neutral Line

* Results [dB μ V] = Reading [dB μ V] + LISN [dB] + Cable Loss [dB]

* Margin [dB] = Results [dB μ V] - Limit [dB μ V]

4.1.5 Test data (Asymmetric mode)

[10 Mbps]

[Quasi-Peak]

Frequency [MHz]	ISN [dB]	Cable Loss [dB]	Limit [dB μ V]	Reading [dB μ V]	Results [dB μ V]	Margin [dB]
0.31	9.76	0.01	90.97	63.65	73.42	-17.55
0.67	9.62	0.02	87.00	63.13	72.77	-14.23
1.35	9.53	0.04	87.00	56.26	65.83	-21.17

[Average]

Frequency [MHz]	ISN [dB]	Cable Loss [dB]	Limit [dB μ V]	Reading [dB μ V]	Results [dB μ V]	Margin [dB μ V]
	* Average mode was not recorded, because Quasi-Peak values were under the Average limit.					

* Results [dB μ V] = Reading [dB μ V] + ISN [dB] + Cable Loss [dB]

* Margin [dB] = Results [dB μ V] - Limit [dB μ V]

[100 Mbps]

[Quasi-Peak]

Frequency [MHz]	ISN [dB]	Cable Loss [dB]	Limit [dB μ V]	Reading [dB μ V]	Results [dB μ V]	Margin [dB]
0.61	9.51	0.02	87.00	62.16	71.69	-15.31
1.35	9.41	0.04	87.00	56.37	65.82	-21.18
5.84	9.33	0.16	87.00	51.63	61.12	-25.88

[Average]

Frequency [MHz]	ISN [dB]	Cable Loss [dB]	Limit [dB μ V]	Reading [dB μ V]	Results [dB μ V]	Margin [dB μ V]
	* Average mode was not recorded, because Quasi-Peak values were under the Average limit.					

* **Results [dB μ V]** = Reading [dB μ V] + ISN [dB] + Cable Loss [dB]

* **Margin [dB]** = Results [dB μ V] - Limit [dB μ V]

Conducted emission, quasi-peak detection: 2.2 dB

Conducted emission, average detection: 2.2 dB

Conducted emission, Telecom port : 1.8 dB

The measurement uncertainty is given with a confidence of 95 % with the coverage factor, $k = 2$.

4.1.6 Test graph (AC mains power ports)

[Hot line]

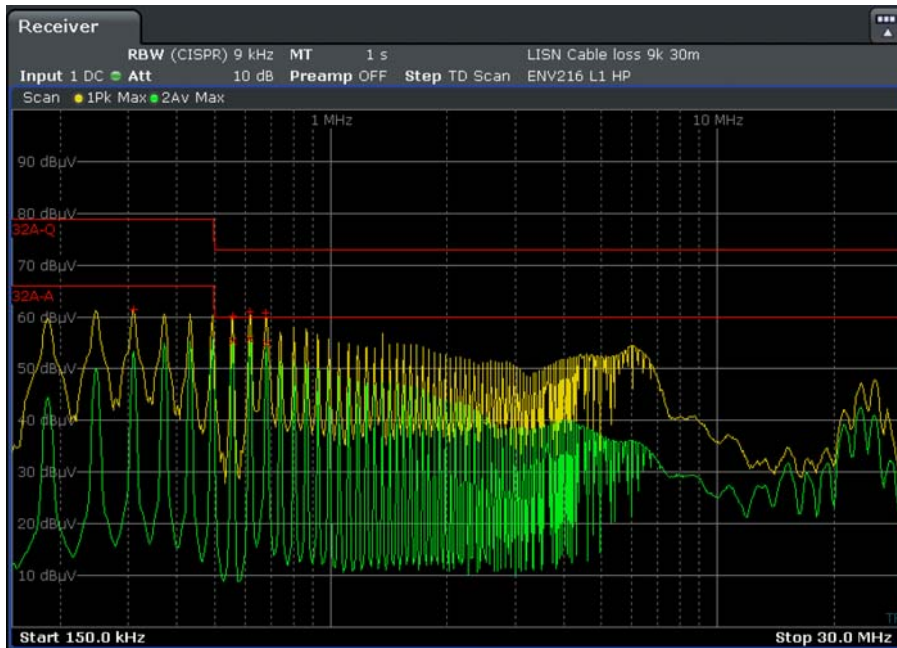

* — : Quasi-Peak, — : Average

[Neutral line]

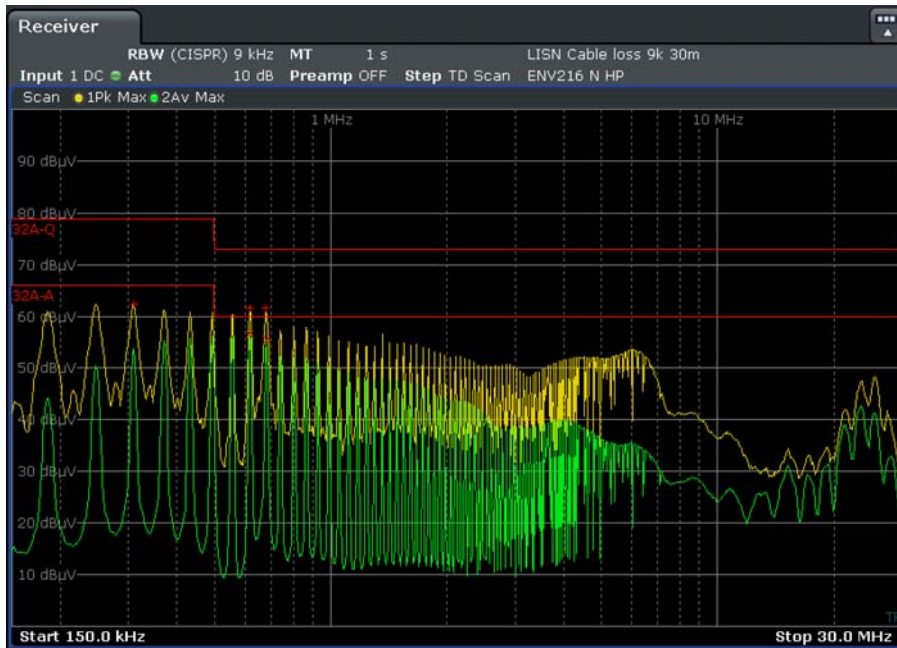

* — : Quasi-Peak, — : Average



4.1.7 Test graph (Asymmetric mode)

[10 Mbps]



* — : Quasi-Peak, — : Average

[100 Mbps]

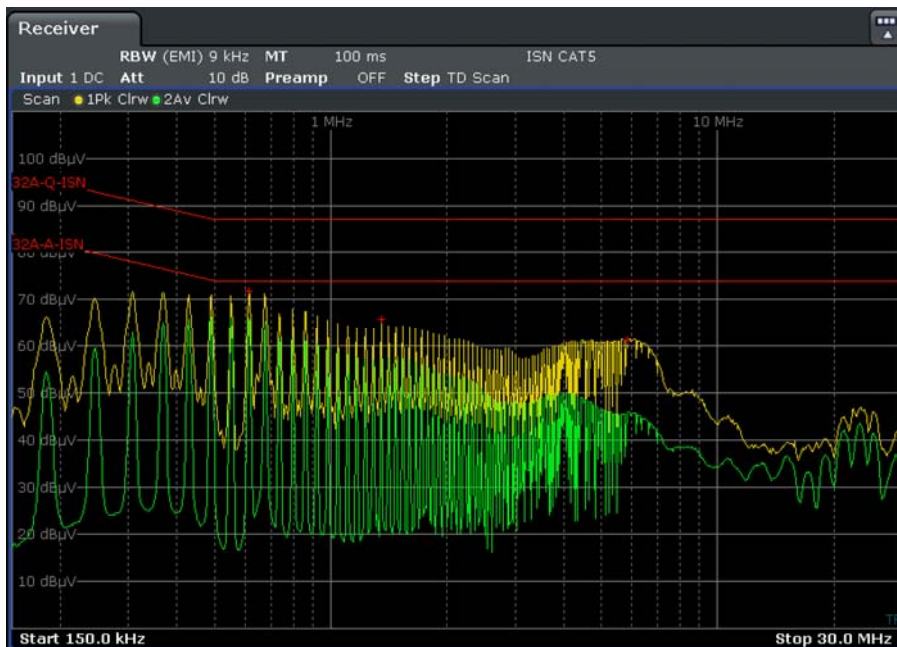

* — : Quasi-Peak, — : Average

4.2 Radiated disturbance (below 1 GHz)

Test Standard	EN 55032:2015, Class A		
Test venue	10 m chamber		
Tested Date	2018.09.26		
Input Ratings	230 V~, 50 Hz		
Temperature	(22.4 ± 0.1) °C	Humidity	(48.8 ± 0.1) % R.H.
Test result	Met Class A / Pass		

4.2.1 Limit

Frequency range [MHz]	Measurement		Class A limits [dB μ V/m]
	Distance [m]	Detector type / bandwidth	
30 ~ 230	10	Quasi Peak / 120 kHz	40
230 ~ 1 000			47
30 ~ 230	3		50
230 ~ 1 000			57

Frequency range [MHz]	Measurement		Class B limits [dB μ V/m]
	Distance [m]	Detector type / bandwidth	
30 ~ 230	10	Quasi Peak / 120 kHz	30
230 ~ 1 000			37
30 ~ 230	3		40
230 ~ 1 000			47

4.2.2 Test set-up and procedure

A pretest was performed at 3 m distance in a semi-anechoic chamber for searching correct frequency.

The final test was done at a 10 m open area test site with a quasi-peak detector.

EUT was placed on a non-metallic table height of 0.8 m above the reference ground plane.

Cables were folded back and forth forming a bundle 0.3 m to 0.4 m long and were hanged at a 0.4 m height to the ground plane.

Cables connected to EUT were fixed to cause maximum emission. Test was made with the antenna positioned in both the horizontal and vertical planes of polarization.

The measurement antenna was varied in height above the conducting ground plane to obtain the maximum signal strength.

4.2.3 Test equipment used

Equipment	Model	Serial No.	Vendor	Next Cal. Date	Use
Test Receiver	ESR7	101969	ROHDE & SCHWARZ	2019.08.03	■
BI-LOG ANT	VULB 9163	691	SCHWARZBECK	2020.01.03	■
Antenna Mast	MA4000-EP	-	Innco systems GmbH	-	■
Turntable	DT3000-t2	-	Innco systems GmbH	-	■
Controller	CO3000	-	Innco systems GmbH	-	■

4.2.4 Test data

- Frequency range : 30 MHz ~ 1 000 MHz
- Bandwidth : 120 kHz
- Distance : 10 m

Frequency [MHz]	Reading [dBμV]	Antenna Polarity [H/V]	Height [m]	Antenna Factor [dB/m]	Cable Loss [dB]	Amp. Gain [dB]	Results [dBμV/m]	Limit [dBμV/m]	Margin [dB]
37.52	17.40	V	1.00	10.94	1.34	-	29.68	40.00	-10.32
44.37	16.06	V	1.00	13.30	1.50	-	30.86	40.00	-9.14
54.09	17.92	H	4.00	12.83	1.71	-	32.46	40.00	-7.54
109.63	15.75	V	1.00	10.26	2.40	-	28.41	40.00	-11.59
501.00	13.19	H	4.00	17.51	5.57	-	36.27	47.00	-10.73

* Remark: "H" Horizontal, "V" Vertical

* **Results [dBμV/m]** = Reading [dBμV] + Antenna Factor [dB/m] + Cable Loss [dB] – Amp. Gain [dB]

* **Margin [dB]** = Results [dBμV/m] – Limit [dBμV/m]

Radiated emission electric field intensity, 30 MHz ~ 1 000 MHz: 3.3 dB

The measurement uncertainty is given with a confidence of 95 % with the coverage factor, $k = 2$.

4.3 Radiated disturbance (above 1 GHz)

Test Standard	EN 55032:2015, Class A		
Test venue	10 m chamber		
Tested Date	2018.09.26		
Input Ratings	230 V~, 50 Hz		
Temperature	(22.6 ± 0.1) °C	Humidity	(48.6 ± 0.1) % R.H.
Test result	Met Class A / Pass		

4.3.1 Limit

Frequency range [MHz]	Measurement		Class A limits [dB μ V/m]
	Distance [m]	Detector type / bandwidth	
1 000 ~ 3 000	3	Peak / 1 MHz	76
3 000 ~ 6 000			80
1 000 ~ 3 000		Average / 1 MHz	56
3 000 ~ 6 000			60

Frequency range [MHz]	Measurement		Class B limits [dB μ V/m]
	Distance [m]	Detector type / bandwidth	
1 000 ~ 3 000	3	Peak / 1 MHz	70
3 000 ~ 6 000			74
1 000 ~ 3 000		Average / 1 MHz	50
3 000 ~ 6 000			54

4.3.2 Test set-up and procedure

The final test was done at a 3 m chamber with a peak and average detector.

EUT was placed on a non-metallic table height of 0.8 m above the reference ground plane.

Cables were folded back and forth forming a bundle 0.3 m to 0.4 m long and were hanged at a 0.4 m height to the ground plane.

Cables connected to EUT were fixed to cause maximum emission.

Test was made with the antenna positioned in both the horizontal and vertical planes of polarization.

The measurement antenna was varied in height above the conducting ground plane to obtain the maximum signal strength.

4.3.3 Test equipment used

Equipment	Model	Serial No.	Vendor	Next Cal. Date	Use
BAND REJECT FILTER	WRCJV8-2355-2395-2495-2535-35SS	1	WAINWRIGHT INSTRUMENTS GMBH	2019.02.01	□
Test Receiver	ESR7	101184	ROHDE & SCHWARZ	2019.02.01	□
Test Receiver	ESR7	101969	ROHDE & SCHWARZ	2019.08.03	■
HORN ANTENNA	BBHA 9120D	768	Schwarzbeck	2018.11.02	□
Horn Antenna	BBHA 9120 D	769	Schwarzbeck	2019.09.25	■
Antenna Mast	-	-	Audix Coporation	-	□
Antenna Mast	MA4640/800-XP-ET	-	Innco systems GmbH	-	■
Turntable	DT3000-t2	-	Innco systems GmbH	-	■
Controller	CO3000	-	Innco systems GmbH	-	■
Turn Table	act-t300	-	Audix Coporation	-	□
Controller	EM 1000	060558	Audix Corporation	-	□
Microwave Preamplifier	8449B	3008A02014	Agilent	2019.02.06	□
Microwave Preamplifier	8449B	3008A02413	Agilent	2019.04.09	■

4.3.4 Test data

- Frequency range : 1 000 MHz ~ 6 000 MHz
- Bandwidth : 1 MHz
- Distance : 3 m

[Horizontal]

[Peak]

Frequency [MHz]	Reading [dB μ V]	Height [m]	Antenna Factor [dB/m]	Cable Loss [dB]	Amp. Gain [dB]	Results [dB μ V/m]	Limit [dB μ V/m]	Margin [dB]
1 177	50.77	1.00	24.73	6.35	37.53	44.32	76.00	-31.68
1 402	54.17	1.00	24.60	7.02	37.18	48.61	76.00	-27.39
1 611	55.02	1.00	25.01	7.64	36.99	50.68	76.00	-25.32
1 814	51.81	1.00	25.35	8.21	36.90	48.47	76.00	-27.53
2 053	48.96	1.00	25.79	8.84	36.82	46.77	76.00	-29.23
5 975	39.72	1.00	32.84	16.04	36.49	52.11	80.00	-27.89

* Results [dB μ V/m] = Reading [dB μ V] + Antenna Factor [dB/m] + Cable Loss [dB] – Amp. Gain [dB]

* Margin [dB] = Results [dB μ V/m] – Limit [dB μ V/m]

[Average]

Frequency [MHz]	Reading [dB μ V]	Height [m]	Antenna Factor [dB/m]	Cable Loss [dB]	Amp. Gain [dB]	Results [dB μ V/m]	Limit [dB μ V/m]	Margin [dB]
1 177	38.78	1.00	24.73	6.35	37.53	32.33	56.00	-23.67
1 402	44.18	1.00	24.60	7.02	37.18	38.62	56.00	-17.38
1 611	43.56	1.00	25.01	7.64	36.99	39.22	56.00	-16.78
1 814	40.00	1.00	25.35	8.21	36.90	36.66	56.00	-19.34
2 053	45.62	1.00	25.79	8.84	36.82	43.43	56.00	-12.57
5 975	27.86	1.00	32.84	16.04	36.49	40.25	60.00	-19.75

* Results [dB μ V/m] = Reading [dB μ V] + Antenna Factor [dB/m] + Cable Loss [dB] – Amp. Gain [dB]

* Margin [dB] = Results [dB μ V/m] – Limit [dB μ V/m]

[Vertical]

[Peak]

Frequency [MHz]	Reading [dBμV]	Height [m]	Antenna Factor [dB/m]	Cable Loss [dB]	Amp. Gain [dB]	Results [dBμV/m]	Limit [dBμV/m]	Margin [dB]
1 004	48.71	1.00	24.85	5.83	37.80	41.59	76.00	-34.41
1 590	50.20	1.00	25.19	7.58	37.00	45.97	76.00	-30.03
1 742	47.02	1.00	25.30	8.01	36.93	43.40	76.00	-32.60
3 319	46.36	1.00	28.46	11.73	36.84	49.71	80.00	-30.29
4 549	42.41	1.00	30.44	13.50	36.55	49.80	80.00	-30.20
5 939	40.49	1.00	32.90	15.98	36.48	52.89	80.00	-27.11

* Results [dBμV/m] = Reading [dBμV] + Antenna Factor [dB/m] + Cable Loss [dB] – Amp. Gain [dB]

* Margin [dB] = Results [dBμV/m] – Limit [dBμV/m]

[Average]

Freq. [MHz]	Reading [dBμV]	Height [m]	Antenna Factor [dB/m]	Cable Loss [dB]	Amp. Gain [dB]	Results [dBμV/m]	Limit [dBμV/m]	Margin [dB]
1 004	36.00	1.00	24.85	5.83	37.80	28.88	56.00	-27.12
1 590	40.25	1.00	25.19	7.58	37.00	36.02	56.00	-19.98
1 742	34.74	1.00	25.30	8.01	36.93	31.12	56.00	-24.88
3 319	34.96	1.00	28.46	11.73	36.84	38.31	60.00	-21.69
4 549	30.60	1.00	30.44	13.50	36.55	37.99	60.00	-22.01
5 939	27.79	1.00	32.90	15.98	36.48	40.19	60.00	-19.81

* Results [dBμV/m] = Reading [dBμV] + Antenna Factor [dB/m] + Cable Loss [dB] – Amp. Gain [dB]

* Margin [dB] = Results [dBμV/m] – Limit [dBμV/m]

Radiated emission electric field intensity, above 1 GHz: 4.8 dB

The measurement uncertainty is given with a confidence of 95 % with the coverage factor, $k = 2$

4.4 Harmonics current emissions

Test Standard	EN 61000-3-2:2014		
Test venue	H/F Field		
Tested Date	2018.09.26		
Input Ratings	230 V~, 50 Hz		
Temperature	(22.3 ± 0.1) °C	Humidity	(48.3 ± 0.1) % R.H.
Test result	Met Class A / Pass		

4.4.1 Test setup and procedure

The equipment is supplied in series with shunt(s) Rms or current transformer(s) from a source having the same Nominal voltage and frequency as the rated supply voltage and frequency of the Measurements shall be made under Normal load, or conditions for adequate heat discharge, and underequipment.

Normal operating conditions. User's operation controls or automatic programmers shall be set to produce the maximum harmonic component, for each successive harmonic component in turn. For the purpose of harmonic current limitation, equipment is classified as follows:

Class A : Equipment not specified in one of the three other Classes shall be considered as Class A equipment.

- Balanced three-phase equipment;
- Household appliances, excluding equipment identified as class D;
- Tools, excluding portable tools;
- Dimmers for incandescent lamps;
- Audio equipment.

Class B:

- portable tools;
- arc welding equipment which is not professional equipment.

Class C:

- lighting equipment.

Class D: Equipment having a specified power according to 6.2.2 less than or equal to 600 W, of the following types:

- personal computers and personal computer monitors;
- television receivers.
- refrigerators and freezers having one or more variable-speed drives to control compressor motor(s).

4.4.2 Test equipment used

Equipment	Model	Serial No.	Vendor	Next Cal. Date	Use
Hamonics/Flicker	5001IX-208-150/300	S59160	C.I.	2019.08.08	□
Precision Power Analyzer	LMG670	01621511	ZES ZIMMER	2019.02.06	■
Reference Impedance	NI2415	NI2415-3	ZES ZIMMER	-	■
AC Power Source	360-AMX	1774	PACIFIC POWER SOURCE	-	■



4.4.3 Test data

Test Name	Test Result	Limit Usage	Info
Supply Voltage Frequency Test (61000-4-7) [L1]	OK		50.00 Hz (50.00 Hz ± 0.5%)
Supply peak voltage test (61000-4-7) [L1]	OK		
Positive peak test	OK		All positive peak values within the allowed range
Negative peak test	OK		All negative peak values within the allowed range
Supply peak position test (61000-4-7) [L1]	OK		All peak values within the allowed range
Supply Voltage Harmonic Distortion Test (61000-4-7) [L1]	OK		
Voltage Distortion H2	OK	3.7%	0.01% < 0.20%
Voltage Distortion H3	OK	2.5%	0.02% < 0.90%
Voltage Distortion H4	OK	3.7%	0.01% < 0.20%
Voltage Distortion H5	OK	0.7%	0.00% < 0.40%
Voltage Distortion H6	OK	1.7%	0.00% < 0.20%
Voltage Distortion H7	OK	1.5%	0.00% < 0.30%
Voltage Distortion H8	OK	2.1%	0.00% < 0.20%
Voltage Distortion H9	OK	1.9%	0.00% < 0.20%
Voltage Distortion H10	OK	4.6%	0.01% < 0.20%
Voltage Distortion H11	OK	2.8%	0.00% < 0.10%
Voltage Distortion H12	OK	9.0%	0.01% < 0.10%
Voltage Distortion H13	OK	4.4%	0.00% < 0.10%
Voltage Distortion H14	OK	4.7%	0.00% < 0.10%
Voltage Distortion H15	OK	0.9%	0.00% < 0.10%
Voltage Distortion H16	OK	2.2%	0.00% < 0.10%
Voltage Distortion H17	OK	4.1%	0.00% < 0.10%
Voltage Distortion H18	OK	1.0%	0.00% < 0.10%
Voltage Distortion H19	OK	1.0%	0.00% < 0.10%
Voltage Distortion H20	OK	1.0%	0.00% < 0.10%
Voltage Distortion H21	OK	2.5%	0.00% < 0.10%
Voltage Distortion H22	OK	0.8%	0.00% < 0.10%
Voltage Distortion H23	OK	1.1%	0.00% < 0.10%
Voltage Distortion H24	OK	1.2%	0.00% < 0.10%
Voltage Distortion H25	OK	1.7%	0.00% < 0.10%
Voltage Distortion H26	OK	1.1%	0.00% < 0.10%
Voltage Distortion H27	OK	1.2%	0.00% < 0.10%
Voltage Distortion H28	OK	0.7%	0.00% < 0.10%
Voltage Distortion H29	OK	1.2%	0.00% < 0.10%
Voltage Distortion H30	OK	0.8%	0.00% < 0.10%
Voltage Distortion H31	OK	2.3%	0.00% < 0.10%
Voltage Distortion H32	OK	1.3%	0.00% < 0.10%
Voltage Distortion H33	OK	1.1%	0.00% < 0.10%
Voltage Distortion H34	OK	1.7%	0.00% < 0.10%
Voltage Distortion H35	OK	2.2%	0.00% < 0.10%
Voltage Distortion H36	OK	1.7%	0.00% < 0.10%
Voltage Distortion H37	OK	2.6%	0.00% < 0.10%
Voltage Distortion H38	OK	1.8%	0.00% < 0.10%



Voltage Distortion H39	OK	1.0%	0.00% < 0.10%
Voltage Distortion H40	OK	1.4%	0.00% < 0.10%
Frequency groups up to 9kHz (61000-4-7) [L1]	OK		
Table 1 Harmonic Current Test (61000-3-2) [L1]	OK		
Harmonic Current Test 100%	OK		
100% Test H2	OK		No test required (0.000 A < 0.005 A)
100% Test H3	OK	0.8%	Limit met (0.018 A < 2.300 A)
100% Test H4	OK		No test required (0.000 A < 0.005 A)
100% Test H5	OK	1.6%	Limit met (0.018 A < 1.140 A)
100% Test H6	OK		No test required (0.000 A < 0.005 A)
100% Test H7	OK	2.2%	Limit met (0.017 A < 0.770 A)
100% Test H8	OK		No test required (0.000 A < 0.005 A)
100% Test H9	OK	3.9%	Limit met (0.016 A < 0.400 A)
100% Test H10	OK		No test required (0.000 A < 0.005 A)
100% Test H11	OK	4.3%	Limit met (0.014 A < 0.330 A)
100% Test H12	OK		No test required (0.000 A < 0.005 A)
100% Test H13	OK	6.1%	Limit met (0.013 A < 0.210 A)
100% Test H14	OK		No test required (0.000 A < 0.005 A)
100% Test H15	OK	7.4%	Limit met (0.011 A < 0.150 A)
100% Test H16	OK		No test required (0.000 A < 0.005 A)
100% Test H17	OK	7.2%	Limit met (0.009 A < 0.132 A)
100% Test H18	OK		No test required (0.000 A < 0.005 A)
100% Test H19	OK	6.6%	Limit met (0.008 A < 0.118 A)
100% Test H20	OK		No test required (0.000 A < 0.005 A)
100% Test H21	OK	5.8%	Limit met (0.006 A < 0.107 A)
100% Test H22	OK		No test required (0.000 A < 0.005 A)
100% Test H23	OK		No test required (0.005 A < 0.005 A)
100% Test H24	OK		No test required (0.000 A < 0.005 A)
100% Test H25	OK		No test required (0.003 A



			< 0.005 A)
100% Test H26	OK		No test required (0.000 A < 0.005 A)
100% Test H27	OK		No test required (0.002 A < 0.005 A)
100% Test H28	OK		No test required (0.000 A < 0.005 A)
100% Test H29	OK		No test required (0.002 A < 0.005 A)
100% Test H30	OK		No test required (0.000 A < 0.005 A)
100% Test H31	OK		No test required (0.001 A < 0.005 A)
100% Test H32	OK		No test required (0.000 A < 0.005 A)
100% Test H33	OK		No test required (0.001 A < 0.005 A)
100% Test H34	OK		No test required (0.000 A < 0.005 A)
100% Test H35	OK		No test required (0.001 A < 0.005 A)
100% Test H36	OK		No test required (0.000 A < 0.005 A)
100% Test H37	OK		No test required (0.002 A < 0.005 A)
100% Test H38	OK		No test required (0.000 A < 0.005 A)
100% Test H39	OK		No test required (0.002 A < 0.005 A)
100% Test H40	OK		No test required (0.000 A < 0.005 A)
Harmonic Current Test 150%	OK		
150% Test H2	OK		No test required (0.000 A < 0.005 A)
150% Test H3	OK	0.5%	Limit met (0.018 A < 3.450 A)
150% Test H4	OK		No test required (0.000 A < 0.005 A)
150% Test H5	OK	1.0%	Limit met (0.018 A < 1.710 A)
150% Test H6	OK		No test required (0.000 A < 0.005 A)
150% Test H7	OK	1.5%	Limit met (0.017 A < 1.155 A)
150% Test H8	OK		No test required (0.000 A < 0.005 A)
150% Test H9	OK	2.6%	Limit met (0.016 A < 0.600 A)
150% Test H10	OK		No test required (0.000 A < 0.005 A)
150% Test H11	OK	2.9%	Limit met (0.014 A < 0.495 A)
150% Test H12	OK		No test required (0.000 A < 0.005 A)
150% Test H13	OK	4.1%	Limit met (0.013 A <



			0.315 A)
150% Test H14	OK		No test required (0.000 A < 0.005 A)
150% Test H15	OK	5.0%	Limit met (0.011 A < 0.225 A)
150% Test H16	OK		No test required (0.000 A < 0.005 A)
150% Test H17	OK	4.8%	Limit met (0.010 A < 0.199 A)
150% Test H18	OK		No test required (0.000 A < 0.005 A)
150% Test H19	OK	4.4%	Limit met (0.008 A < 0.178 A)
150% Test H20	OK		No test required (0.000 A < 0.005 A)
150% Test H21	OK	3.9%	Limit met (0.006 A < 0.161 A)
150% Test H22	OK		No test required (0.000 A < 0.005 A)
150% Test H23	OK		No test required (0.005 A < 0.005 A)
150% Test H24	OK		No test required (0.000 A < 0.005 A)
150% Test H25	OK		No test required (0.003 A < 0.005 A)
150% Test H26	OK		No test required (0.000 A < 0.005 A)
150% Test H27	OK		No test required (0.002 A < 0.005 A)
150% Test H28	OK		No test required (0.000 A < 0.005 A)
150% Test H29	OK		No test required (0.002 A < 0.005 A)
150% Test H30	OK		No test required (0.000 A < 0.005 A)
150% Test H31	OK		No test required (0.001 A < 0.005 A)
150% Test H32	OK		No test required (0.000 A < 0.005 A)
150% Test H33	OK		No test required (0.001 A < 0.005 A)
150% Test H34	OK		No test required (0.000 A < 0.005 A)
150% Test H35	OK		No test required (0.001 A < 0.005 A)
150% Test H36	OK		No test required (0.000 A < 0.005 A)
150% Test H37	OK		No test required (0.002 A < 0.005 A)
150% Test H38	OK		No test required (0.000 A < 0.005 A)
150% Test H39	OK		No test required (0.002 A < 0.005 A)
150% Test H40	OK		No test required (0.000 A < 0.005 A)
Harmonic Current Test	OK		



200%			
200% Test H2	OK		No test required (0.000 A < 0.005 A)
200% Test H3	OK	0.4%	Limit met (0.018 A < 4.600 A)
200% Test H4	OK		No test required (0.000 A < 0.005 A)
200% Test H5	OK	0.8%	Limit met (0.018 A < 2.280 A)
200% Test H6	OK		No test required (0.000 A < 0.005 A)
200% Test H7	OK	1.1%	Limit met (0.017 A < 1.540 A)
200% Test H8	OK		No test required (0.000 A < 0.005 A)
200% Test H9	OK	2.0%	Limit met (0.016 A < 0.800 A)
200% Test H10	OK		No test required (0.000 A < 0.005 A)
200% Test H11	OK	2.2%	Limit met (0.014 A < 0.660 A)
200% Test H12	OK		No test required (0.000 A < 0.005 A)
200% Test H13	OK	3.1%	Limit met (0.013 A < 0.420 A)
200% Test H14	OK		No test required (0.000 A < 0.005 A)
200% Test H15	OK	3.7%	Limit met (0.011 A < 0.300 A)
200% Test H16	OK		No test required (0.000 A < 0.005 A)
200% Test H17	OK	3.6%	Limit met (0.010 A < 0.265 A)
200% Test H18	OK		No test required (0.000 A < 0.005 A)
200% Test H19	OK	3.3%	Limit met (0.008 A < 0.237 A)
200% Test H20	OK		No test required (0.000 A < 0.005 A)
200% Test H21	OK	2.9%	Limit met (0.006 A < 0.214 A)
200% Test H22	OK		No test required (0.000 A < 0.005 A)
200% Test H23	OK		No test required (0.005 A < 0.005 A)
200% Test H24	OK		No test required (0.000 A < 0.005 A)
200% Test H25	OK		No test required (0.003 A < 0.005 A)
200% Test H26	OK		No test required (0.000 A < 0.005 A)
200% Test H27	OK		No test required (0.002 A < 0.005 A)
200% Test H28	OK		No test required (0.000 A < 0.005 A)
200% Test H29	OK		No test required (0.002 A



			< 0.005 A)
200% Test H30	OK		No test required (0.000 A < 0.005 A)
200% Test H31	OK		No test required (0.001 A < 0.005 A)
200% Test H32	OK		No test required (0.000 A < 0.005 A)
200% Test H33	OK		No test required (0.001 A < 0.005 A)
200% Test H34	OK		No test required (0.000 A < 0.005 A)
200% Test H35	OK		No test required (0.001 A < 0.005 A)
200% Test H36	OK		No test required (0.000 A < 0.005 A)
200% Test H37	OK		No test required (0.002 A < 0.005 A)
200% Test H38	OK		No test required (0.000 A < 0.005 A)
200% Test H39	OK		No test required (0.002 A < 0.005 A)
200% Test H40	OK		No test required (0.000 A < 0.005 A)
POHC Test	OK		POHC Limit met (0.010 A < 0.251 A)
100% Test H2	OK		No test required (0.000 A < 0.005 A)
100% Test H3	OK	0.8%	Limit met (0.018 A < 2.300 A)
100% Test H4	OK		No test required (0.000 A < 0.005 A)
100% Test H5	OK	1.6%	Limit met (0.018 A < 1.140 A)
100% Test H6	OK		No test required (0.000 A < 0.005 A)
100% Test H7	OK	2.2%	Limit met (0.017 A < 0.770 A)
100% Test H8	OK		No test required (0.000 A < 0.005 A)
100% Test H9	OK	3.9%	Limit met (0.016 A < 0.400 A)
100% Test H10	OK		No test required (0.000 A < 0.005 A)
100% Test H11	OK	4.3%	Limit met (0.014 A < 0.330 A)
100% Test H12	OK		No test required (0.000 A < 0.005 A)
100% Test H13	OK	6.1%	Limit met (0.013 A < 0.210 A)
100% Test H14	OK		No test required (0.000 A < 0.005 A)
100% Test H15	OK	7.4%	Limit met (0.011 A < 0.150 A)
100% Test H16	OK		No test required (0.000 A < 0.005 A)
100% Test H17	OK	7.2%	Limit met (0.009 A <



			0.132 A)
100% Test H18	OK		No test required (0.000 A < 0.005 A)
100% Test H19	OK	6.6%	Limit met (0.008 A < 0.118 A)
100% Test H20	OK		No test required (0.000 A < 0.005 A)
150% Test H21	OK	3.9%	Limit met (0.006 A < 0.161 A)
100% Test H22	OK		No test required (0.000 A < 0.005 A)
150% Test H23	OK		No test required (0.005 A < 0.005 A)
100% Test H24	OK		No test required (0.000 A < 0.005 A)
150% Test H25	OK		No test required (0.003 A < 0.005 A)
100% Test H26	OK		No test required (0.000 A < 0.005 A)
150% Test H27	OK		No test required (0.002 A < 0.005 A)
100% Test H28	OK		No test required (0.000 A < 0.005 A)
150% Test H29	OK		No test required (0.002 A < 0.005 A)
100% Test H30	OK		No test required (0.000 A < 0.005 A)
150% Test H31	OK		No test required (0.001 A < 0.005 A)
100% Test H32	OK		No test required (0.000 A < 0.005 A)
150% Test H33	OK		No test required (0.001 A < 0.005 A)
100% Test H34	OK		No test required (0.000 A < 0.005 A)
150% Test H35	OK		No test required (0.001 A < 0.005 A)
100% Test H36	OK		No test required (0.000 A < 0.005 A)
150% Test H37	OK		No test required (0.002 A < 0.005 A)
100% Test H38	OK		No test required (0.000 A < 0.005 A)
150% Test H39	OK		No test required (0.002 A < 0.005 A)

The uncertainty of our equipments for harmonic measurement is 0.2 %.
 The measurement uncertainty is given with a confidence of 95 % with the coverage factor, $k = 2$.

4.5 Voltage changes, Voltage fluctuations and flicker

Test Standard	EN 61000-3-3:2013		
Test venue	H/F Field		
Tested Date	2018.09.26		
Input Ratings	230 V~, 50 Hz		
Temperature	(22.1 ± 0.1) °C	Humidity	(48.1 ± 0.1) % R.H.
Test result	Met / Pass		

4.5.1 Test set-up and procedure

EUT was connected to the power analyzer system.

Measurement was performed to obtain the desired flicker parameters.

The measuring time depends on which parameters are to be measured.

Plt = 2 h

Pst = 10 min

Controls and automatic programs shall be set to produce the most unfavorable sequence of voltage changes, using only those combinations of controls and programs are mentioned by the manufacturer in the instruction manual.

4.5.2 Test equipment used

Equipment	Model	Serial No.	Vendor	Next Cal. Date	Use
Hamonics/Flicker	5001IX-208-150/300	S59160	C.I.	2019.08.08	□
Precision Power Analyzer	LMG670	01621511	ZES ZIMMER	2019.02.06	■
Reference Impedance	NI2415	NI2415-3	ZES ZIMMER	-	■
AC Power Source	360-AMX	1774	PACIFIC POWER SOURCE	-	■

4.5.3 Test data

Test Name	Test Result	Limit Usage	Info
Dc Test [L1]	OK	0.1%	0.0% < 3.3%
Dmax Test [L1]	OK	0.1%	0.0% < 4.0%
Pst Test [L1]	OK	1.6%	0.016 < 1.000
Plt Test [L1]	OK	1.7%	0.011 < 0.650

The uncertainty of our equipment for flicker measurement is 5 %.

The measurement uncertainty is given with a confidence of 95 % with the coverage factor, $k = 2$.

4.6 Electrostatic discharge

Test Standard	EN 61000-4-2:2009, Criteria: B		
Test venue	EMS 2		
Test Level	HCP/VCP/Contact: ± 4 kV Air: ± 2 kV, ± 4 kV, ± 8 kV		
Discharge Impedance	330 Ω / 150 pF		
Test Time	at least 25 times for each adapting point		
Tested Date	2018.09.27		
Input Ratings	230 V~, 50 Hz		
Temperature	(22.9 \pm 0.1) $^{\circ}$ C	Humidity	(50.9 \pm 0.1) % R.H.
Atmospheric pressure	100.5 kPa		
Test Result	A Met by Criterion / Pass		

4.6.1 Test set-up and procedure

A ground reference plane was located on the floor, and connected to earth via a low Impedance connection.

The return cable of the ESD generator was connected to the reference plane.

In case of floor standing equipment, EUT was placed on the reference plane on 0.1 m of insulating Support.

In case of table top equipment, EUT was placed on a wooden table 0.8 m above the reference grounded floor.

A horizontal coupling plane (HCP) was placed on the table, and Connected to the reference plane via a 470 kohm resistor located in each end (0.5 mm insulating support between EUT and HCP).

In both cases a vertical coupling plane (VCP) of 0.5 m x 0.5 m was located 0.1 m from the EUT's sides.

The VCP was connected to the reference plane in the same matter as the HCP.

4.6.2 Test equipment used

Equipment	Model	Serial No.	Vendor	Next Cal. Date	Use
ESD Simulator	ESS-2000	4010C63927	NoiseKen	2019.08.08	<input type="checkbox"/>
HAEFELY TEST AG	ONYX 16	177897	HAEFELY TECHNOLOGY	2019.02.08	<input checked="" type="checkbox"/>
HCP	-	-	-	-	<input checked="" type="checkbox"/>
VCP	-	-	-	-	<input checked="" type="checkbox"/>

4.6.3 Test data

Location	Applied Level (±)	Criteria	Results
VCP	4 kV	B	A
HCP	4 kV	B	A

* There was no deviation from normal operation condition.

Location (EUT)	Applied Level (±)	Method	Criteria	Results
(1) Port Part	4 kV	Contact	B	A
No Discharge point	2 kV, 4 kV, 8 kV	Air	B	-

* There was no deviation from normal operation condition.

It has been demonstrated that the ESD generator meets the specified requirements in the standard with at least a 95 % confidence.

4.6.4 ESD points

[ESD points 1]

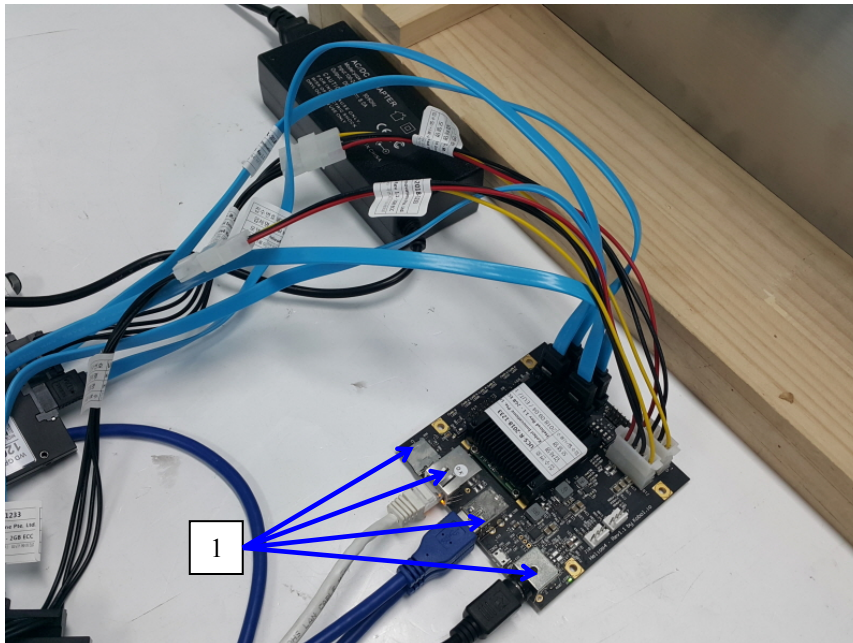

4.7 Radiated RF electromagnetic field immunity

Test Standard	EN 61000-4-3:2006/A2:2010, Criteria: A		
Test venue	10 chamber		
Tested Frequency	80 MHz ~ 1.0 GHz		
Test Level/Modulation	3 V/m (AM 80 %, 1 kHz)		
Distance	3 m		
Dwell Time	1 s		
Step Size	log 1 % step		
Tested Date	2018.09.27		
Input Ratings	230 V~, 50 Hz		
Temperature	(21.5 ± 0.5) °C	Humidity	(47.2 ± 0.5) % R.H.
Atmospheric pressure	100.5 kPa		
Test Result	A Met by Criterion / Pass		

4.7.1 Test set-up and procedure

The test was performed at 3 m full anechoic chamber.

For floor standing equipment, the EUT was standing on the floor.

For tabletop equipment, the EUT was located on a wooden table 0.8 m above the floor.

The EUT was tested all sides, horizontal and vertical polarization

4.7.2 Test equipment used

Equipment	Model	Serial No.	Vendor	Next Cal. Date	Use
SOUND ACOUSTIC TESTER	PST-1000	15004	P&E	2019.02.06	<input type="checkbox"/>
MICROPHONE	UC-52	127762	RION	2019.02.06	<input type="checkbox"/>
SIGNAL GENERATOR	SMC100A	101441	ROHDE & SCHWARZ	2019.08.03	<input type="checkbox"/>
EMP Series Power Meter	E4419B	MY45104421	Agilent	2019.08.03	<input type="checkbox"/>
E-SERIES AVG POWER SENSOR	E9304A	MY41499023	Agilent	2019.08.03	<input type="checkbox"/>
E-SERIES AVG POWER SENSOR	E9304A	MY41499045	Agilent	2019.08.03	<input type="checkbox"/>
SIGNAL GENERATOR	APSIN6010	111-433500010-0759	ANAPICO	2019.08.03	<input checked="" type="checkbox"/>
EMP Series Power Meter	E4419B	GB40202769	Agilent	2019.08.03	<input checked="" type="checkbox"/>
POWER SENSOR	8481B	US37290730	Agilent	2019.08.03	<input checked="" type="checkbox"/>
POWER SENSOR	8481B	US37290731	Agilent	2019.08.03	<input checked="" type="checkbox"/>
RF AMPLIFIER	150W1000M1	0331746	AMPLIFRER RESEARCH	-	<input type="checkbox"/>
LOG-PER ANTENNA	VULP 9118 E	855	SCHWARZBECK	-	<input type="checkbox"/>
BI-LOG ANT	CBL6141A	4217	SCHAFFNER	-	<input type="checkbox"/>
RF AMPLIFIER	SS3T6G100	-	Sangsan	-	<input type="checkbox"/>
RF AMPLIFIER	SS1T3G250	-	Sangsan	-	<input type="checkbox"/>
RF AMPLIFIER	SS20T1000M1k	-	Sangsan	-	<input checked="" type="checkbox"/>
LOG-PER ANTENNA	VULP 9118 E	855	SCHWARZBECK	-	<input checked="" type="checkbox"/>
HORN ANTENNA	OBH1080	201804039001	OCEAN MICROWAVE	-	<input type="checkbox"/>
HORN ANTENNA	AT4002A	0330909	AMPLIFRER RESEARCH		<input type="checkbox"/>



4.7.3 Test data

Location (EUT)	Antenna Polarization	Results	Results
Front Side	Horizontal	A	A
	Vertical	A	A
Rear Side	Horizontal	A	A
	Vertical	A	A
Left Side	Horizontal	A	A
	Vertical	A	A
Right Side	Horizontal	A	A
	Vertical	A	A

* There was no deviation from normal operation condition.

The measurement uncertainty is 1.3 dB

The measurement uncertainty is given with a confidence of 95 % with the coverage factor, $k = 2$.

4.8 Electric fast transient/burst immunity

Test Standard	EN 61000-4-4:2012, Criteria: B		
Test venue	EMS 2		
Coupling	Mains port - Coupling Decoupling Network, Signal port - Capacitive Coupling Clamp		
Test Level	AC Mains: ± 1 kV Peak, Signal: ± 0.5 kV Peak		
Repetition Freq.	5 kHz, Tr / Th = 5 / 50 ns		
Coupling Time	60 s		
Tested Date	2018.09.27		
Input Ratings	230 V~, 50 Hz		
Temperature	$(22.7 \pm 0.1) ^\circ\text{C}$	Humidity	$(50.7 \pm 0.1) \% \text{ R.H.}$
Atmospheric pressure	100.5 kPa		
Test Result	A Met by Criterion / Pass		

4.8.1 Test set-up and procedure

A ground reference plane was located on the floor.

EFT generator was connected to reference ground plane via low impedance connection.

For floor standing equipment, EUT was placed on a 0.1 m wooden table.

For tabletop equipment, EUT was placed on a 0.1 m above the ground reference plane.

Test generator and coupling/decoupling network was placed on, and bounded to, the ground reference plane.

When using the coupling clamp, the minimum distance between the coupling plates and all other conductive surfaces, except the ground reference plane beneath the coupling clamp, Shall be 0.5 m.

4.8.2 Test equipment used

Equipment	Model	Serial No.	Vendor	Next Cal. Date	Use
EMC IMMUNITY TEST	EMCPRO PLUS	0906221	ThermoFisher Scientific	2019.08.03	<input type="checkbox"/>
Capacitive Clamp	CCL	0904227	ThermoFisher Scientific	2019.08.03	<input type="checkbox"/>
COMPACT IMMUNITY TEST SYSTEM	AXOS5	180998	HAEFELY EMC TECHNOLOGY	2019.02.01	<input checked="" type="checkbox"/>
THREE PHASES EXTERNAL CDN	FP-COMB32	181211	HAEFELY EMC TECHNOLOGY	2019.02.02	<input checked="" type="checkbox"/>
Capacitive Coupling Clamp	IP4B	181514	HAEFELY EMC TECHNOLOGY	2019.02.01	<input type="checkbox"/>



4.8.3 Test data

EFT Coupling Point	Level (\pm)	Criteria	Results
L	1 kV	B	A
N	1 kV	B	A
PE	1 kV	B	A
L - N	1 kV	B	A
L - PE	1 kV	B	A
N - PE	1 kV	B	A
L - N - PE	1 kV	B	A
LAN	0.5 kV	B	A

* There was no deviation from normal operation condition.

It has been demonstrated that the EFT/Burst generator meets the specified requirements in the standard with at least a 95 % confidence.

4.9 Surge immunity

Test Standard	EN 61000-4-5:2014, Criteria: B		
Test venue	EMS 2		
Coupling	Coupling Decoupling Network		
Test Level	AC Mains (Line to Line): ± 0.5 kV, ± 1 kV (Line to Earth): ± 0.5 kV, ± 1 kV, 2 kV		
Number of surge/time	1 time / 60 s, total 5 times		
Tested Date	2018.09.27		
Input Ratings	230 V~, 50 Hz		
Temperature	$(22.1 \pm 0.5) ^\circ\text{C}$	Humidity	$(50.1 \pm 0.5) \% \text{ R.H.}$
Atmospheric pressure	100.5 kPa		
Test Result	A Met by Criterion / Pass		

4.9.1 Test set-up and procedure

A ground reference plane was located on the floor. SURGE generator was connected to reference ground plane via low impedance connection. For floor standing equipment, EUT was placed on a 0.1 m wooden table.

For table top equipment, EUT was placed on a wooden table (0.1 m) above the reference plane.

4.9.2 Test equipment used

Equipment	Model	Serial No.	Vendor	Next Cal. Date	Use
EMC IMMUNITY TEST	EMCPRO PLUS	0906221	ThermoFisher Scientific	2019.08.03	<input type="checkbox"/>
I/O Lin Coupler/Decoupler	CM-I/OCD	0906226	ThermoFisher Scientific	-	<input type="checkbox"/>
Telecom coupler/Decoupler	CM-TELCD	0905226	ThermoFisher Scientific	-	<input type="checkbox"/>
COMPACT IMMUNITY TEST SYSTEM	AXOS5	180998	HAEFELY EMC TECHNOLOGY	2019.02.01	<input checked="" type="checkbox"/>
THREE PHASES EXTERNAL CDN	FP-COMB32	181211	HAEFELY EMC TECHNOLOGY	2019.02.02	<input type="checkbox"/>



4.9.3 Test data

Coupling Point	Level (±)	Criteria	Results
L to N	0.5 kV, 1 kV	B	A
L to PE	0.5 kV, 1 kV, 2 kV	B	A
N to PE	0.5 kV, 1 kV, 2 kV	B	A

* There was no deviation from normal operation condition.

* The EUT does not have the signal ports that may connect directly to outdoor cables.

It has been demonstrated that the surge tester meets the specified requirements in the standard with at least a 95 % confidence.

4.10 Conducted disturbance induced by RF fields immunity

Test Standard	EN 61000-4-6:2014, Criteria: A		
Test venue	EMS 2		
Tested Frequency	150 kHz ~ 80 MHz		
Test Level/Modulation	3 V, (AM 80 %, 1 kHz)		
Coupling Method	AC Mains: M3, Signal: EM Clamp		
Dwell Time	1 s		
Step Size	log 1 % step		
Tested Date	2018.09.27		
Input Ratings	230 V~, 50 Hz		
Temperature	(21.4 ± 0.2) °C	Humidity	(49.4 ± 0.2) % R.H.
Atmospheric pressure	100.5 kPa		
Test Result	A Met by Criterion / Pass		

4.10.1 Test set-up and procedure

A ground reference plane was located on the floor.

The test was performed on a ground reference plane on a 0.1 m wooden table.

This test were performed using CDN for mains, clamp for signal and injection probe.

The frequency range was swept from 150 kHz to 80 MHz. This frequency range was modulated with 1 kHz sine wave at 80 %.

The signal generators provided the modulated frequency at a 1 % step size.

The power and all network cable, I/O cables longer than 3 m length were tested.

4.10.2 Test equipment used

Equipment	Model	Serial No.	Vendor	Next Cal. Date	Use
SOUND ACOUSTIC TESTER	PST-1000	15004	P&E	2019.02.07	<input type="checkbox"/>
MICROPHONE	UC-52	127773	RION	2019.02.06	<input type="checkbox"/>
CDN M2	FCC-801-M2-16A	091165	FCC	2019.08.03	<input type="checkbox"/>
CDN M3	FCC-801-M3-16A	091994	FCC	2019.08.03	<input checked="" type="checkbox"/>
EM INJECTION CLAMP	F-203I-23mm	091199	FCC	2019.08.06	<input checked="" type="checkbox"/>
Continuous Wave Simulator	CWS 500N1	P1247105423	EM Test	2019.02.01	<input checked="" type="checkbox"/>
Coaxial Fixed Attenuator	ATT6/75	P1306112966	EM Test	2019.02.01	<input checked="" type="checkbox"/>



4.10.3 Test data

Coupling Point	Coupling Method	Criteria	Results
AC Mains	CDN (M3)	A	A
LAN	EM Clamp	A	A

* There was no deviation from normal operation condition.

The measurement uncertainty is 2.2 dB

The measurement uncertainty is given with a confidence of 95 % with the coverage factor, $k = 2$.

4.11 Voltage dips and short interruptions

Test Standard	EN 61000-4-11:2004, Criterion : B or C		
Test venue	EMS 2		
Number of reduction	3		
Duration	10 s		
Tested Date	2018.09.27		
Input Ratings	100-240 V~, 50 Hz		
Temperature	21.6 °C	Humidity	49.6 % R.H.
Atmospheric pressure	100.5 kPa		
Test result	A and C Met by Criterion / Pass		

4.11.1 Test set-up and procedure

The dips/interruption test is only applicable to AC mains.

The dips/interruptions were applied at zero crossing.

4.11.2 Test equipment used

Equipment	Model	Serial No.	Vendor	Next Cal. Date	Use
EMC IMMUNITY TEST	EMCPRO PLUS	0906221	ThermoFisher Scientific	2019.08.03	□
COMPACT IMMUNITY TEST SYSTEM	AXOS5 & DIP 116	180998	HAEFELY EMC TECHNOLOGY	2019.02.01	■

4.11.3 Test data

Test	Test Level (% U _T)	Periods	Criteria	Results
Voltage dips	> 95 %	0.5	B	A (See note 1)
	30 %	25	C	
Voltage interruptions	> 95 %	250	C	C (See note 2)

* Note 1: There was no deviation from normal operation condition.

* Note 2: The power of EUT was turned off during the test, but returned to normal operating condition after the test.

* Test results of both 100 V~ and 240 V are same

It has been demonstrated that the voltage dips and interruptions generator meets the specified requirements in the standard with at least a 95 % confidence.

5. EUT Photos

5.1 Test Setup Photographs

5.1.1 Conducted disturbance (AC mains power ports)

[Front view]



[Rear view]



5.1.2 Conducted disturbance (Asymmetric mode)

[Front view]



[Rear view]



5.1.3 Radiated disturbance (below 1 GHz)

[Front view]

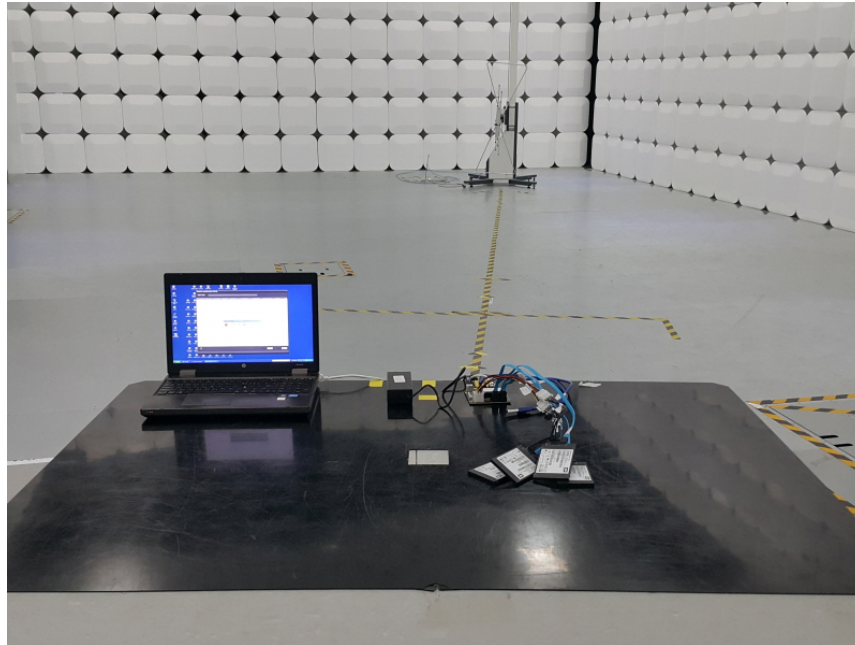

[Rear view]

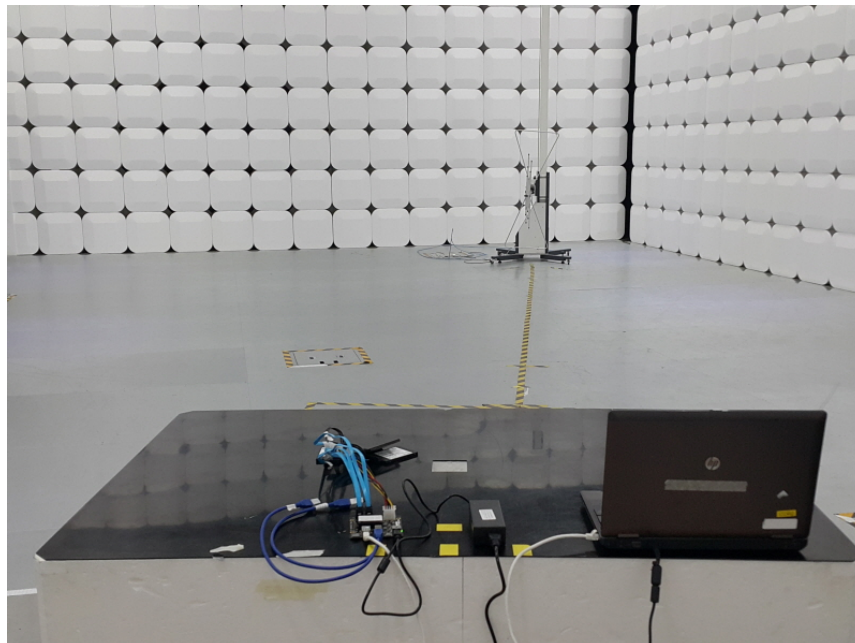

5.1.4 Radiated disturbance (above 1 GHz)

[Front view]



[Rear view]

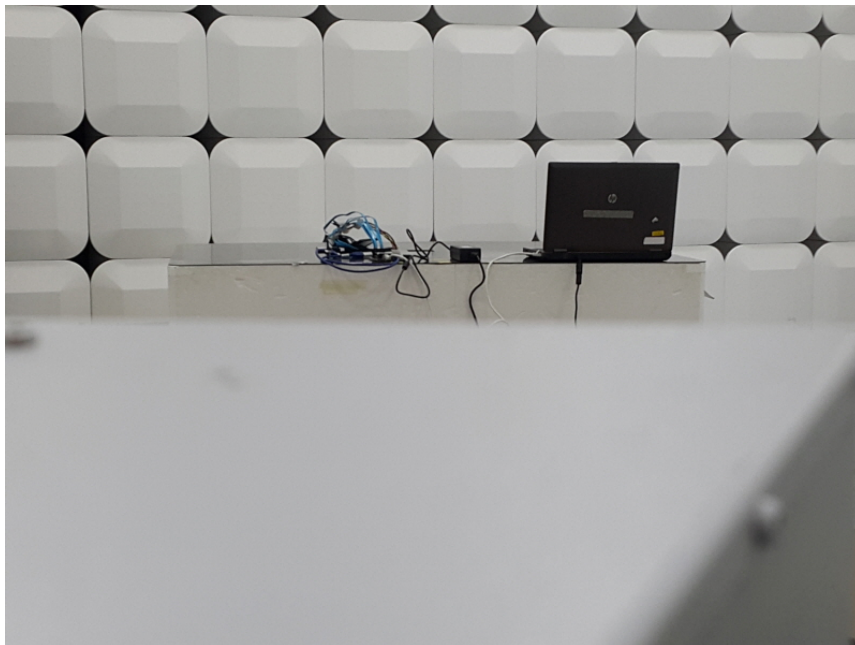

5.1.5 Harmonics current emissions



5.1.6 Voltage changes, Voltage fluctuations and flicker



5.1.7 Electrostatic discharge

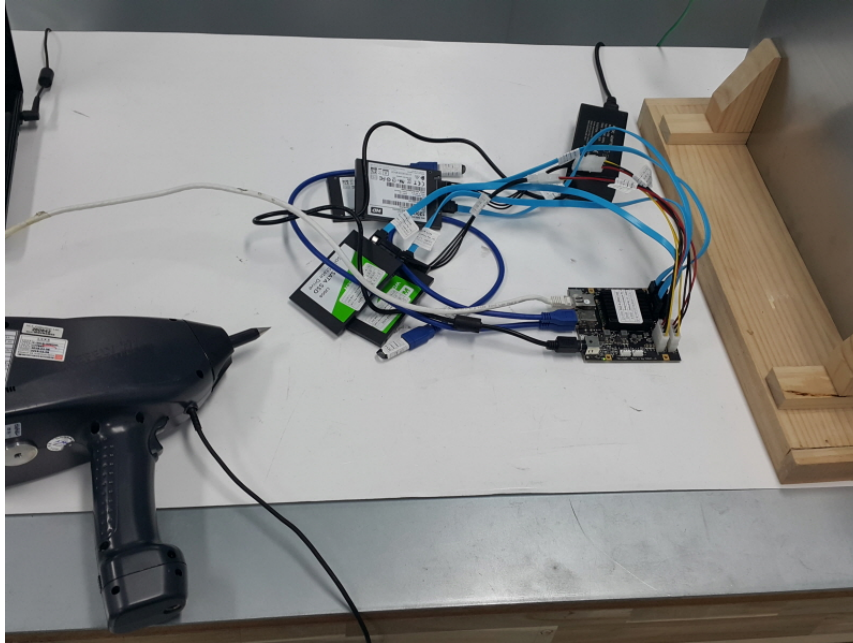

5.1.8 Radiated RF electromagnetic field immunity

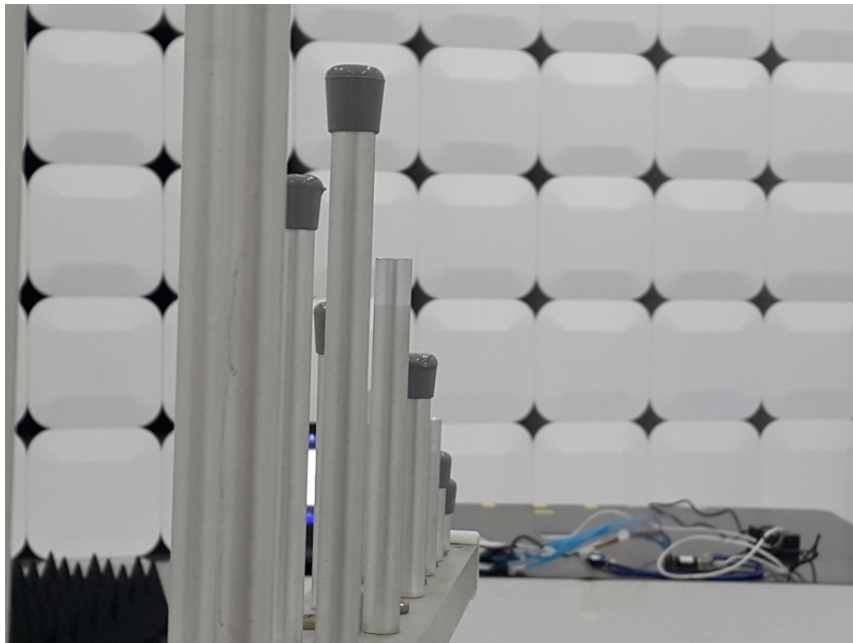

5.1.9 Electric fast transient/burst immunity

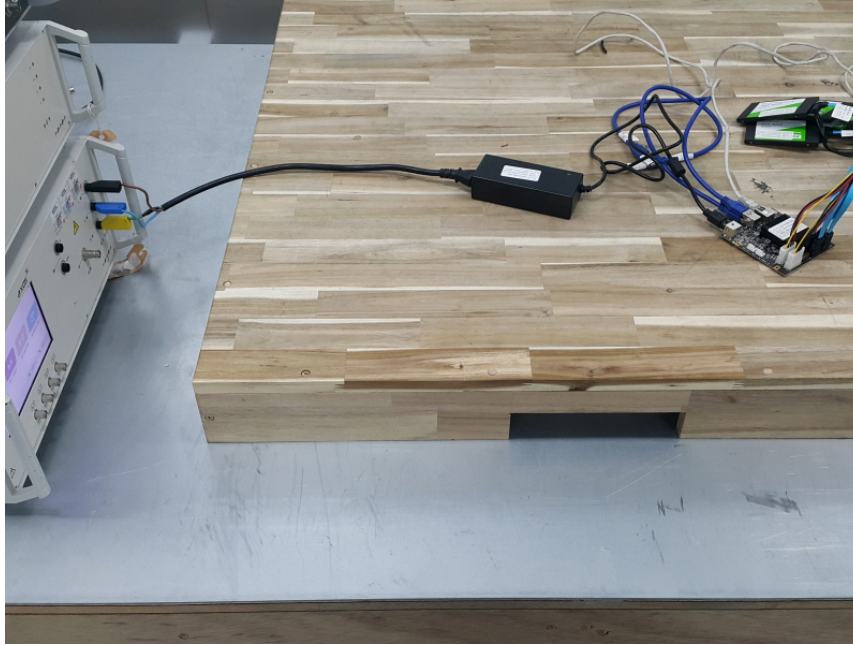

5.1.10 Surge immunity



5.1.11 Conducted disturbance induced by RF fields immunity

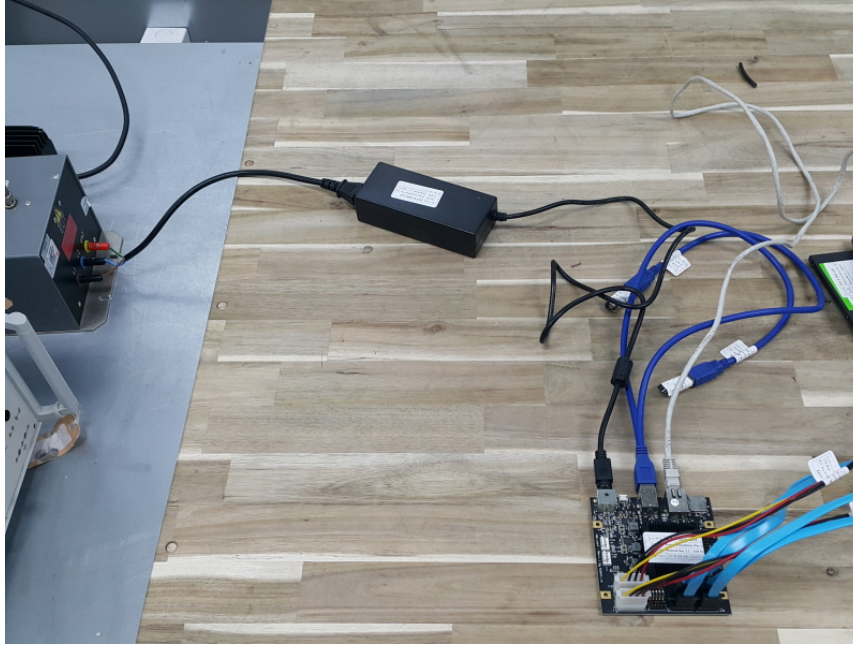

5.1.12 Voltage dips and short interruptions

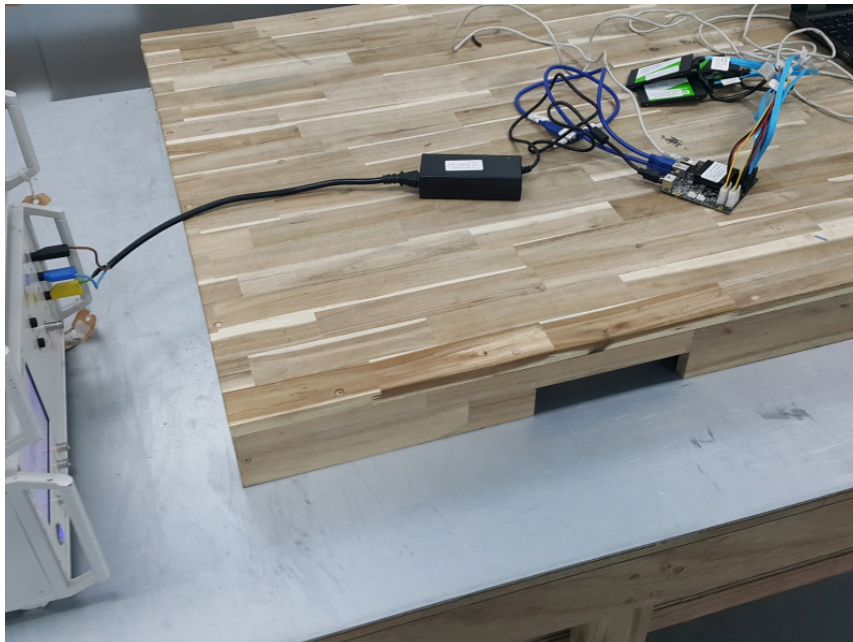

5.2 External Photographs of EUT

[Front view]



[Rear view]

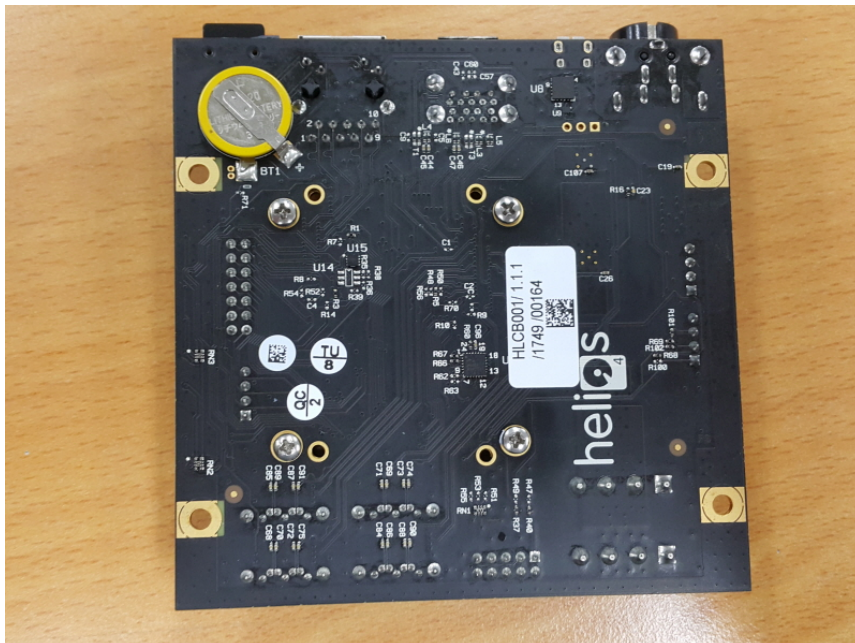



Manufacturer / Approval Declaration

The following identical model(s): R00