



# Helios64 - Test Manual

Version : 0.2  
Date : 29/ 06 / 2020

# Table of Contents

<b>Product overview.....</b>	<b>3</b>
Hardware Description.....	4
Block Diagram.....	5
Helios64 Board.....	5
Rockchip RK3399 SoC.....	5
Interfaces List.....	6
<b>Operating Manual.....</b>	<b>8</b>
Peripheral Kit.....	8
Software Install.....	13
Writing an image to a microSD Card.....	13
System Setup.....	14
Test Application.....	17
Network Config and Credentials.....	17
Connect to Helios64.....	17
Test Suite Usage.....	19
Launch Application.....	19
Run All tests.....	19
Run Ethernet test.....	20
Run SATA test.....	20
Run MicroSD test.....	21
Run eMMC test.....	21
Run USB test.....	22
<b>Troubleshooting.....</b>	<b>24</b>
Troubleshooting table.....	24
Serial Console Access.....	26
Under Windows.....	26
Under Linux (via Terminal).....	28
Login Credentials.....	28
Troubleshooting commands.....	29
Check all drives are detected.....	29
Check IP address is correct.....	29
Check correct System Version is running.....	30
Boot Screen.....	31
U-Boot.....	31
Linux.....	33

## Product overview

Helios64 is a powerful ARM board specially designed for Network Attached Storage (NAS). It is designed around the **Rockchip RK3399** System-on-Chip.

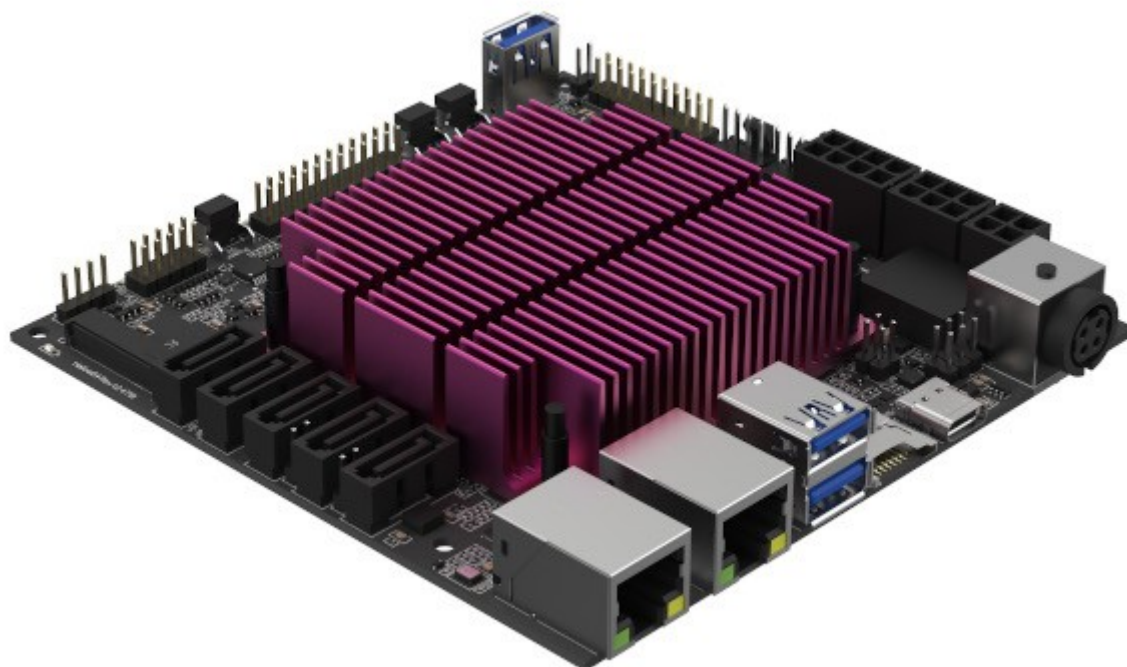

Helios64 is our latest design for the ultimate ARM powered NAS. Compared to the [Helios4](#), it offers improvement on every single key aspect :

- More storage capacity with 5x SATA ports,
- Greater network throughput with Multi-Gigabit Ethernet (2.5 GbE),
- Faster and Larger Memory with 4GB LPDDR4,
- More functionalities with Display Port and DAS modes support,
- Reinforced reliability with Built-in UPS.

## Hardware Description

<b>SoC</b>	
SoC Model	Rockchip RK3399 - Hexacore 2x Cortex-A72 + 4x Cortex-A53
SoC Architecture	ARMv8-A 64-bit
CPU Frequency	A72 : 1.8 GHz A53 : 1.4 GHz
Additional Features	- GPU Mali-T860MP4 - Video Encode/Decoder Engines - Security Acceleration Engines - Secure Boot
<b>Memory</b>	
LPDDR4 RAM	4GB
eMMC 5.1 NAND Flash	16GB
SPI NOR Flash	128Mb
<b>HDD/SSD Interfaces</b>	
SATA 3.0 Ports	5
M.2 SATA 3.0 Slot	1 (shared with SATA port 1)
Max Raw Capacity	80 TB (16 TB drive x 5)
<b>External Interfaces</b>	
Multi-Gigabit LAN Port (2.5Gbe)	1
Gigabit LAN Port (1Gbe)	1
USB Type-C	1
USB 3.0	3
microSD (SDIO 3.0)	1
<b>Developer Interfaces</b>	
GPIO	16
I2C	1
UEXT	1
<b>Others</b>	
PWM FAN	2
On-Board HDD Power	yes
Built-in UPS	yes
RTC Battery	yes
DC input	Dual 12V inputs
Wake-on-LAN	yes
Front Panel Extension	yes

# Block Diagram

## Helios64 Board

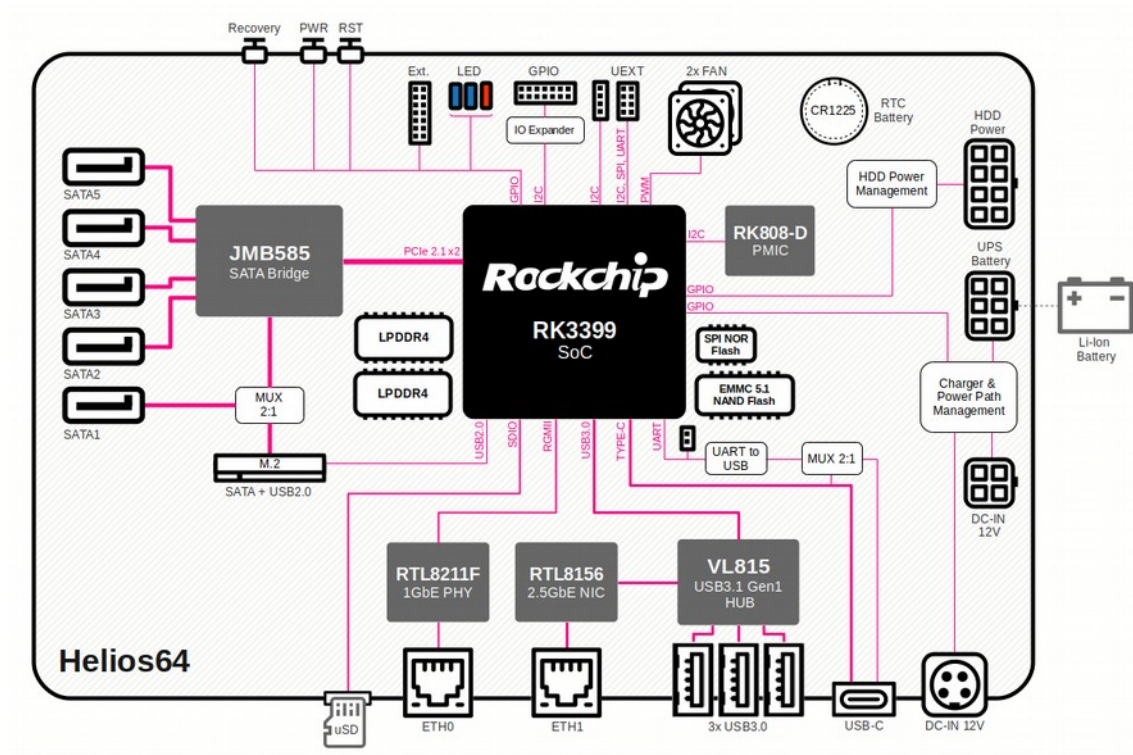

## Rockchip RK3399 SoC

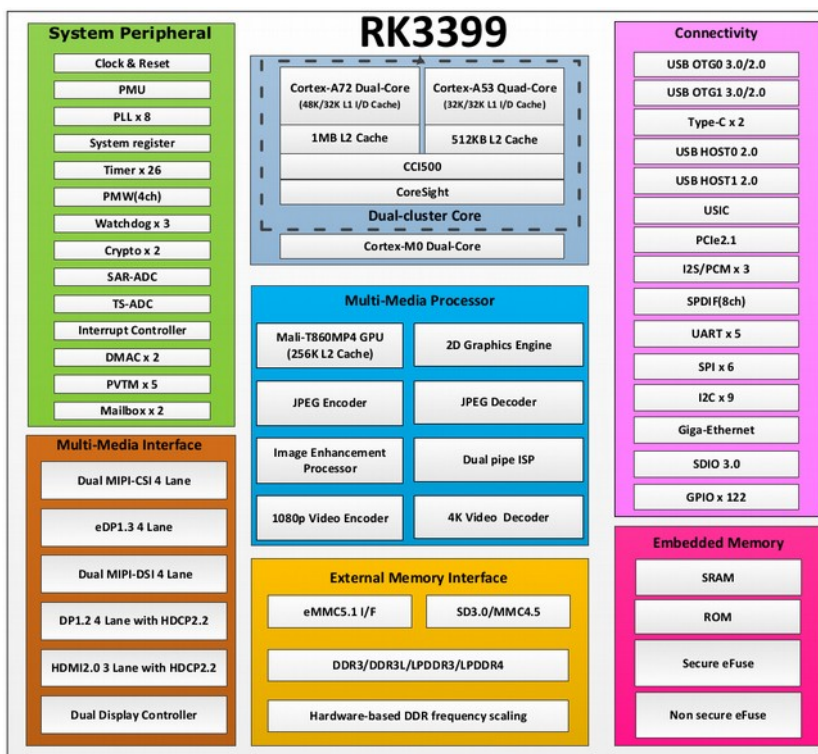

# Interfaces List

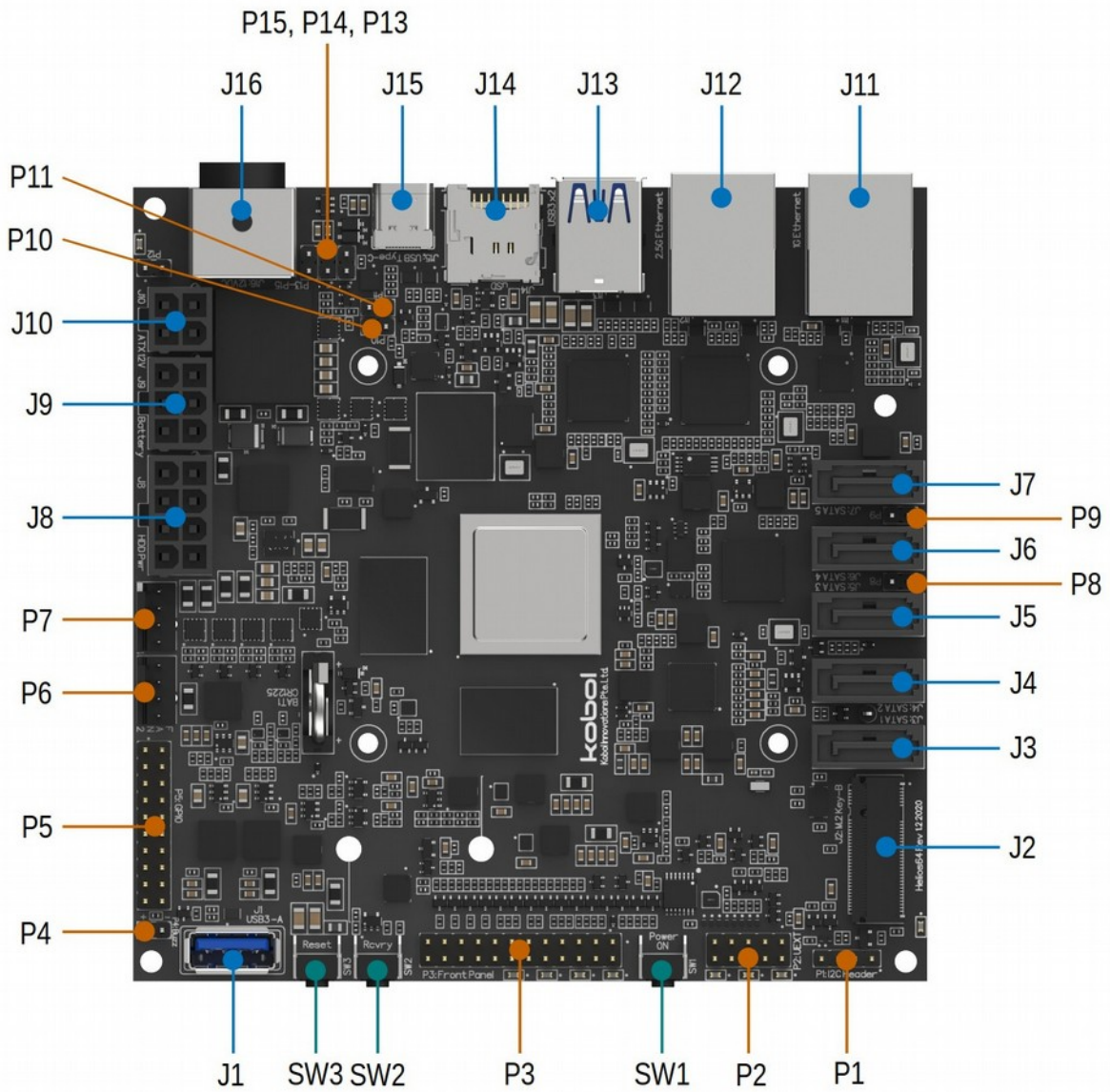

Name	Peripheral Type	Connector Type	Details
J1	USB 3.0	USB 3.0 Type-A	USB 3.0 Port 3
J2	M.2	M.2 Key-B	M.2 Slot for SATA SSD or USB 2.0 Device
J3	SATA	SATA 3.0	Port 0 (SATA1)
J4	SATA	SATA 3.0	Port 1 (SATA2)
J5	SATA	SATA 3.0	Port 2 (SATA3)
J6	SATA	SATA 3.0	Port 3 (SATA4)
J7	SATA	SATA 3.0	Port 4 (SATA5)
J8	HDD Power	8 Pin Mini-Fit Jr	HDD Power 5V + 12V (supports 5x HDD)
J9	UPS Battery	6 Pin Mini-Fit Jr	UPS Battery Power
J10	ATX PSU	4 Pin Mini-Fit Jr	DC input 12V
J11	LAN1	RJ45	Gigabit Ethernet
J12	LAN2	RJ45	2.5 Gigabit Ethernet
J13	USB 3.0 (x2)	Dual USB 3.0 Type-A	USB 3.0 Port 1 and 2
J14	microSD	Push-Push card connector	Support SDHC and SDXC
J15	USB Type-C	USB Type-C Connector	Supports following: - DisplayPort Mode - DAS Mode - Host Mode - Serial Console
J16	AC Adapter	Kycon 4-Pin Mini-DIN	DC input 12V
P1	I2C	4x1 Pin Header	I2C Bus
P2	UEXT	2x5 Pin Header	Universal EXTension (I2C, SPI and UART)
P3	Front Panel	12x2 Pin Header	Front Panel Extension
P4	Buzzer	2x1 Pin Header	Buzzer Alarm Speaker
P5	GPIO	7x2 Pin Header	User Configurable GPIO
P6	PWM Fan	4x1 Pin Header	Fan 1 with PWM support
P7	PWM Fan	4x1 Pin Header	Fan 2 with PWM support
P8	SATA Ctrl. Programming	2x1 Pin Header	SATA Controller Flash Enable
P9	eFuse Programming	2x1 Pin Header	eFuse Power Supply Enable
P10	eMMC Flash Disable	2x1 Pin Header	Disable eMMC
P11	SPI Flash Disable	2x1 Pin Header	Disable SPI Flash
P12	Battery Configuration	2x1 Pin Header	unpopulated
P13	USB Console/Recovery Mode	2x1 Pin Male Header	USB-C HS Mode
P14	UART Debug	2x1 Pin Male Header	UART 2 Debug
P15	ATX Priority Jumper	2x1 Pin Male Header	ATX Supply Priority
SW1	Power Button	Push Button	Power Button
SW2	Recovery Button	Push Button	Recovery Button
SW3	Reset Button	Push Button	Reset Button



# Operating Manual

This section explains how to setup and operate Helios64 in order to exercise all its high speed interfaces.

Helios64 has the following high speed interfaces :

- SATA 3.0 (5x)
- USB 3.0 (3x)
- Type-C (1x)
- 2.5 Gb Ethernet (1x)
- 1Gb Ethernet (1x)
- SDIO / MMC (2x)

## Peripheral Kit

The following peripheral kit is required to exercise all the interfaces listed above.

### MicroSD Card

SanDisk microSD card UHS-I Class 10 - 16GB

Model : SDSQUAR-016G



Quantity : 1

### SATA 3.0 SSD Drive

WD GREEN SATA SSD - 120GB

Model : WDS120G2G0A-00JH30



Quantity : 5



**SATA 3.0 Data Cable (Shielded)**

Length : 50 cm

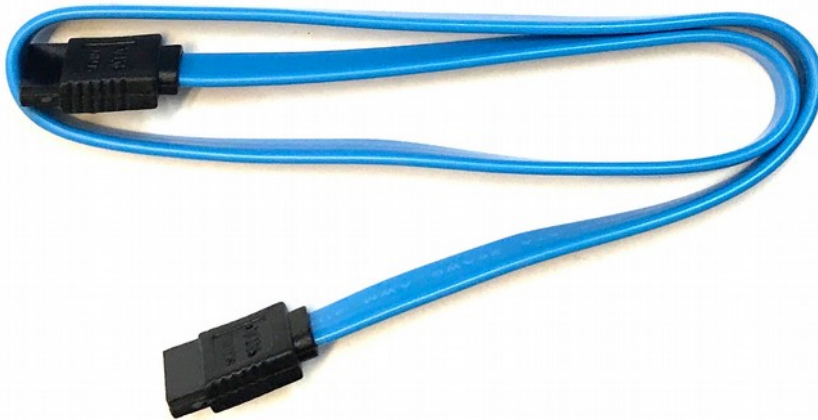

**Quantity : 5**  
*(4x Blue + 1x Red)*

**SATA Power Cable**

Length : total 50 cm



**Quantity : 1**

**USB 3.0 Flash Drive**

SanDisk Ultra Flair - 32GB

Model : SDCZ73-032G



**Quantity : 4**

**USB Type-C to USB3.0 Type-A Adapter**



**Quantity : 1**

**USB 3.0 Extension Cable (Shielded)**

Length : 60cm



**Quantity : 4**

**USB 3.0 to 2.5 Gb Ethernet Adapter**



**Quantity : 1**

**Ethernet Cable - Cat. 6**

Length : 3m



**Quantity : 1**

### AC / DC Power Adapter

Input : 100-240VAC: 50/60Hz

Output : 12V - 10.0A

DC Connector type : Male 4-pin "Kycon"

Cable Length : 1m



Quantity : 1

### Type-C to Type-A USB3.0 Cable (For Debug only)



Quantity : 1

### 70mm PWM Fan (Optional)



Quantity : 1

## Software Install

Helios64 is supported by [Armbian](#) Linux distro which provides Debian Buster and Ubuntu Focal based images.

A customized version of Armbian Buster that includes the Helios64 **Test Application** is pre-installed the eMMC NAND Flash of the Test Unit for the purpose of running the tests described in this manual.

If the unit hasn't been pre-installed with the above operating system, you can use instead an microSD Card. Download the image [here](#) and follow the below instruction on how to write an image on a microSD Card.

*Note : Archives can be uncompressed with 7-Zip on Windows, Keka on OS X and 7z on Linux (apt-get install p7zip-full). RAW images can be written with Etcher (all OS).*

### Writing an image to a microSD Card

Etcher is a graphical SD card writing tool that works on Mac OS, Linux and Windows, and is the easiest option for most users. To write your image with Etcher:

1. [Download Etcher](#) and install it on your computer.
2. Insert the microSD Card inside your SD card reader (microSD to SD adapter might be needed).
3. Open Etcher and select from your local storage the Helios64 .img.xz file you have downloaded.
4. Select the microSD Card you wish to write your image to.
5. Review your selections and click 'Flash!' to begin writing data to the microSD Card.

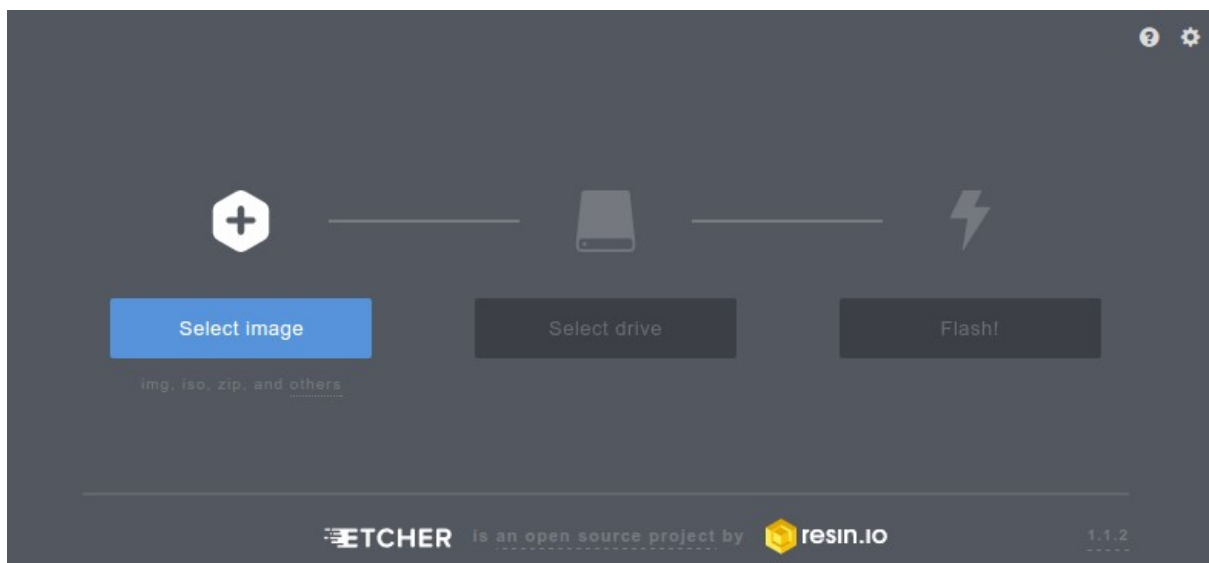

## System Setup

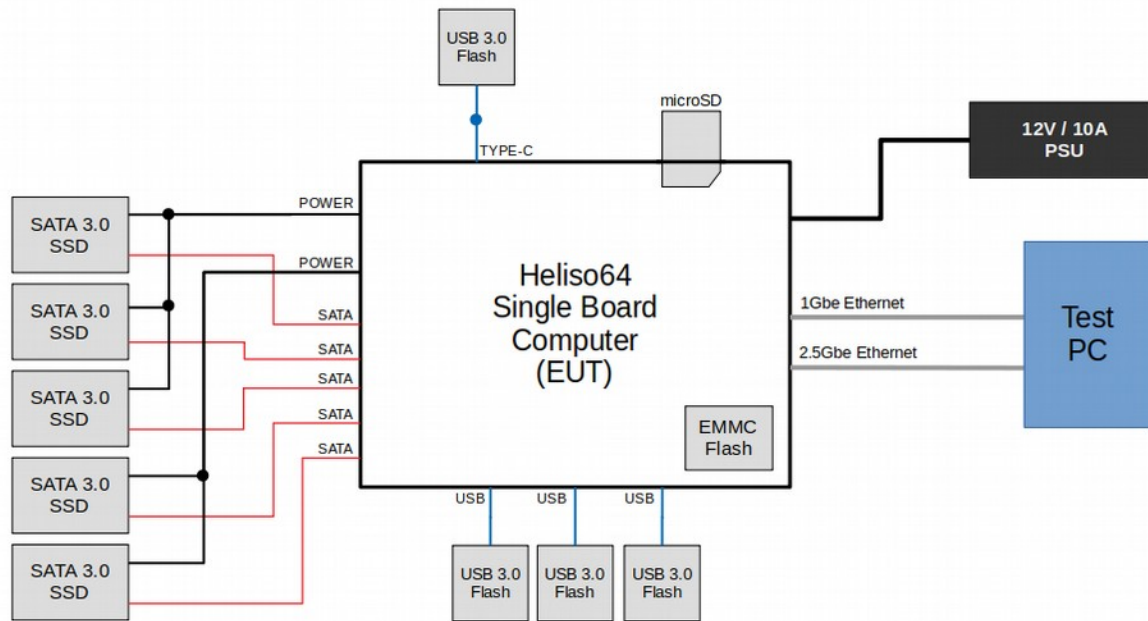

System Setup Diagram

1. Insert the microSD Card
2. Connect the 5x SSD Drives to EUT with SATA Data & Power cables
3. Connect the 4x USB Flash Drive to EUT with USB3.0 Extension cables (Note: for Type-C port use additional adapter)
4. Connect Test PC to EUT 2x Ethernet ports with LAN cables (Note: use USB3.0 to 2.5Gbe Ethernet adapter)
5. Plug PSU cable (DC side)
6. Confirm all connections are correct and match above diagram
7. Plug PSU to AC source
8. Press Power On button for 2 sec

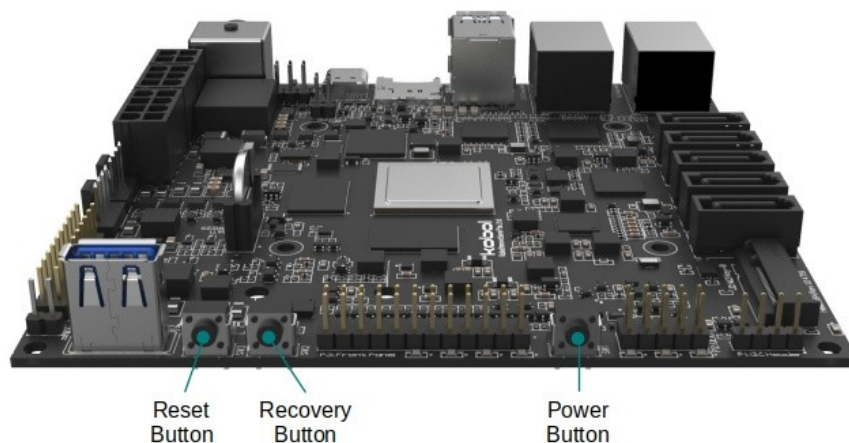



Setup example :

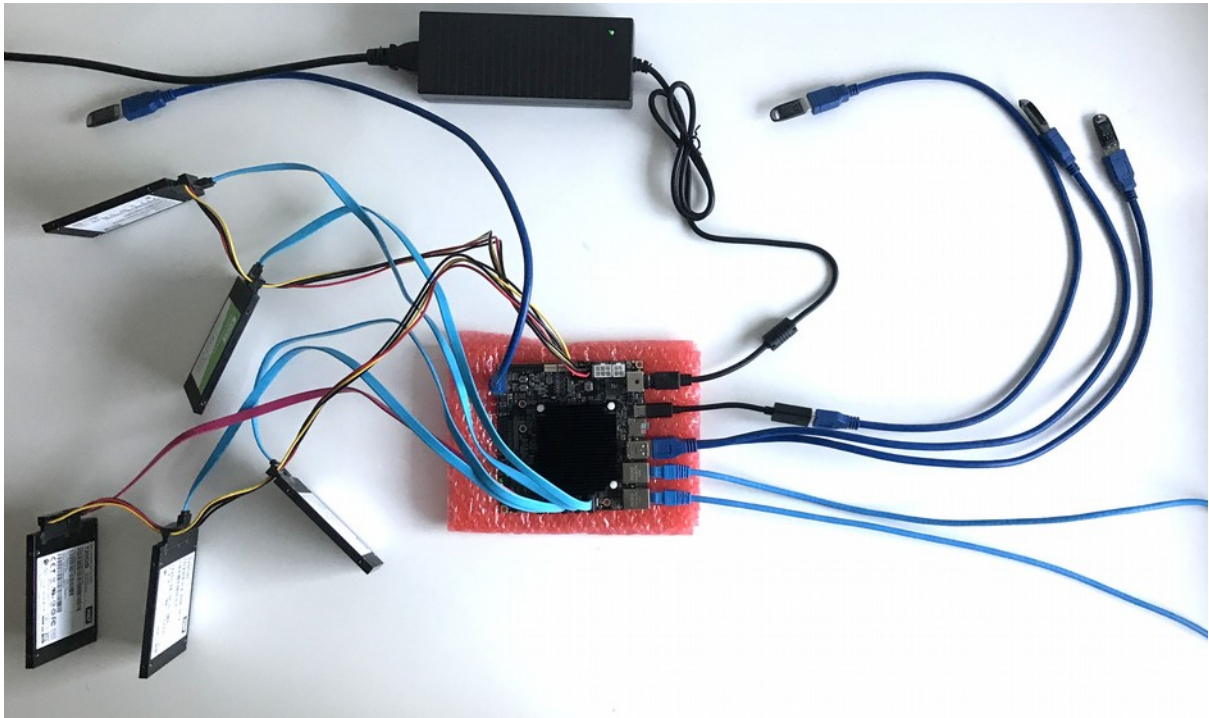



Once the system is powered up, you will see the *LED1*, *LED2* and *LED3*, *LED4* lighting up.

After a 15-30 seconds you should see the *LED6* blinking which indicates the Operating System is up and running.

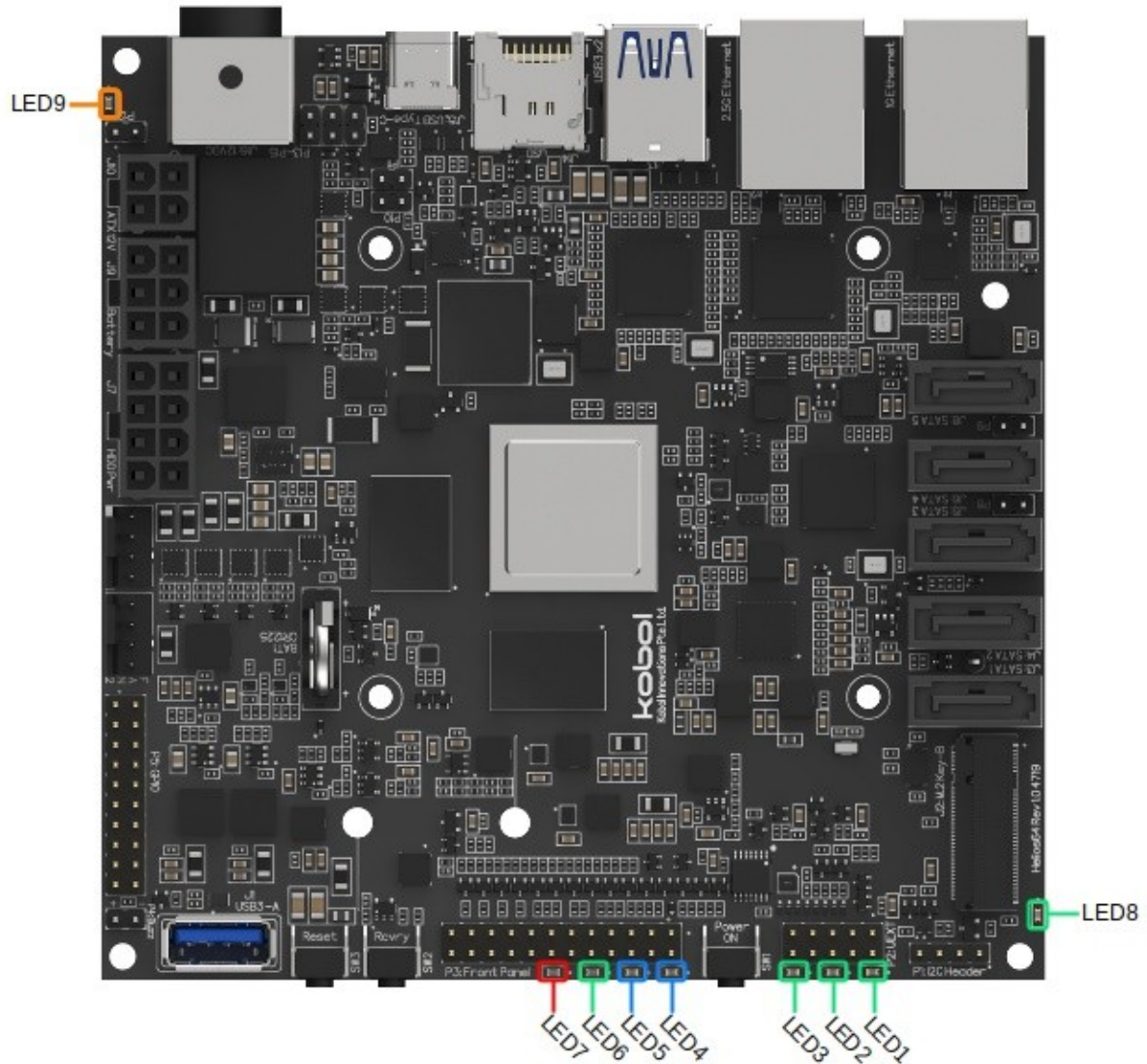

LED Name	Color	Description
LED1	green	System Rail Power
LED2	green	Periph. Rail Power
LED3	green	HDD Rail Power
LED4	blue	System ON
LED5	blue	HDD Activity
LED6	green	System Status/Heartbeat
LED7	red	System Error
LED8	green	M.2 Activity
LED9	orange	Battery Status

## Test Application

The Helios64 Test Suite provides an easy dialog menu where you can toggle for each interface background I/O operations that will exercise the interface. The I/O operations that exercise the interfaces are generated by *fiio* tool. The source code of the Helios64 Test Suite can be found [here](#).

**To operate the Test Suite you will need to connect to Helios64 via SSH.**

## Network Config and Credentials

Helios64 OS has been configured with following configuration:

Network LAN1 (1Gb Port)	IP Address	10.10.0.1
	Netmask	255.255.255.0
Network LAN2 (2.5Gb Port)	IP Address	10.10.1.1
	Netmask	255.255.255.0
Credential	Username	root
	Password	root

## Connect to Helios64

1. Helios64 will automatically provide IP addresses to the Test PC via DHCP. The obtained IP addresses should be within the following ranges :

LAN1 (Test PC built-in LAN) <i>Speed: 1Gb Ethernet</i>	IP Address Range : 10.10.0.20-100 Netmask: 255.255.255.0
LAN2 (USB3.0 to 2.5 GbE Adapter LAN) <i>Speed: 2.5Gb Ethernet</i>	IP Address Range : 10.10.1.20-100 Netmask: 255.255.255.0

2. Connect to Helios64 via SSH.

**a. Under Windows**

- a) [Download PuTTY](#) and install it on your computer.
- b) Run PuTTY from start menu
- c) Setup the connection and press Open

Host Name (or IP address)	10.10.0.1
Port	22
Connection type	SSH



## Test Suite Usage

### Launch Application

To start Helios64 Test Suite use the following command:

```
root@helios64~# helios64_test
```

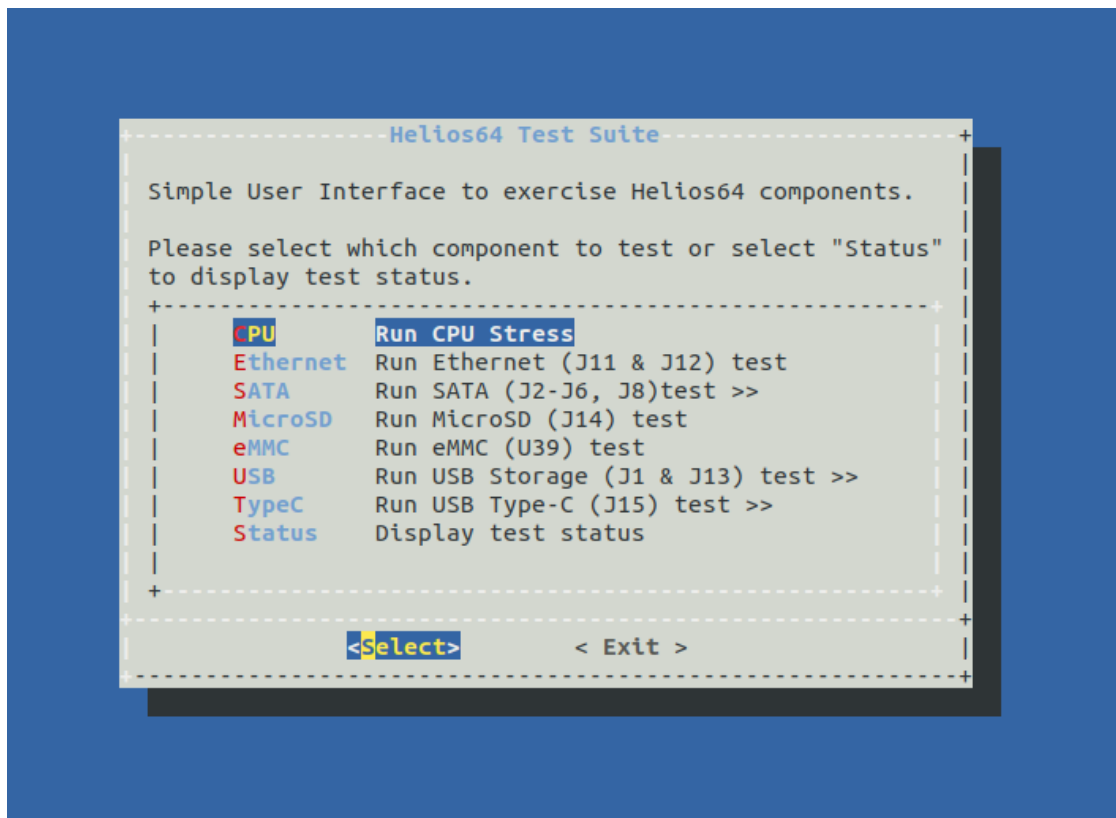

### Run All tests

To automatically start all interface tests at once (Ethernet, SATA, MicroSD, eMMC and USB/Type-C), start the Test Suite with `--all` parameter:

```
root@helios64~# helios64_test --all
```

Run Ethernet test

Select **Ethernet** submenu, then select which Ethernet port to test and press **Apply**.

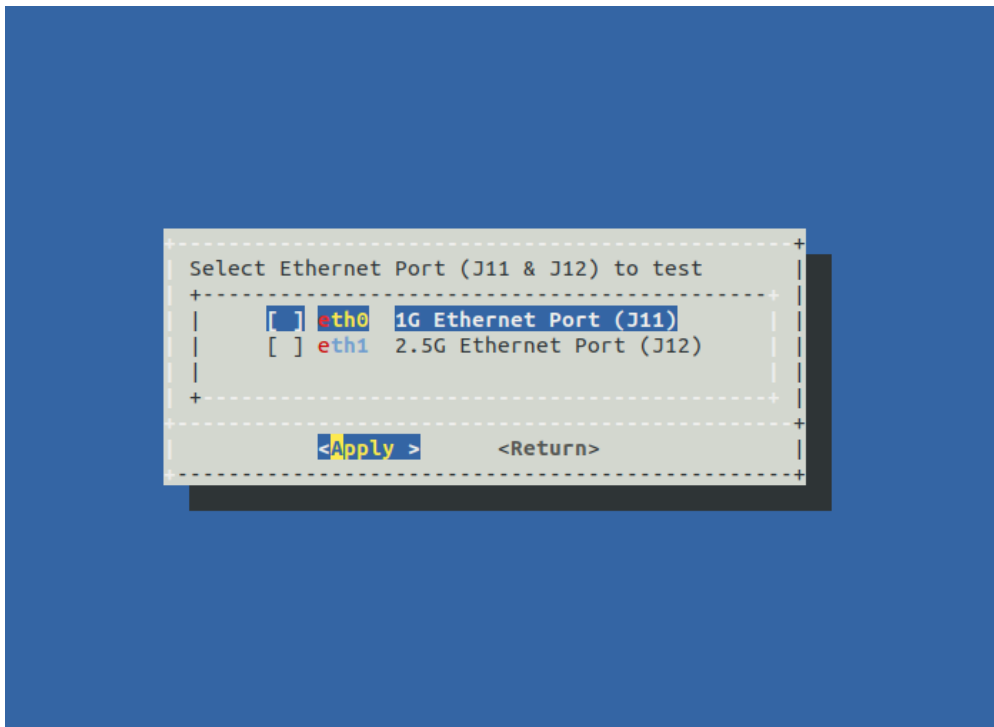

Run SATA test

Select **SATA** submenu, then select which SATA port to test and press **Apply**.

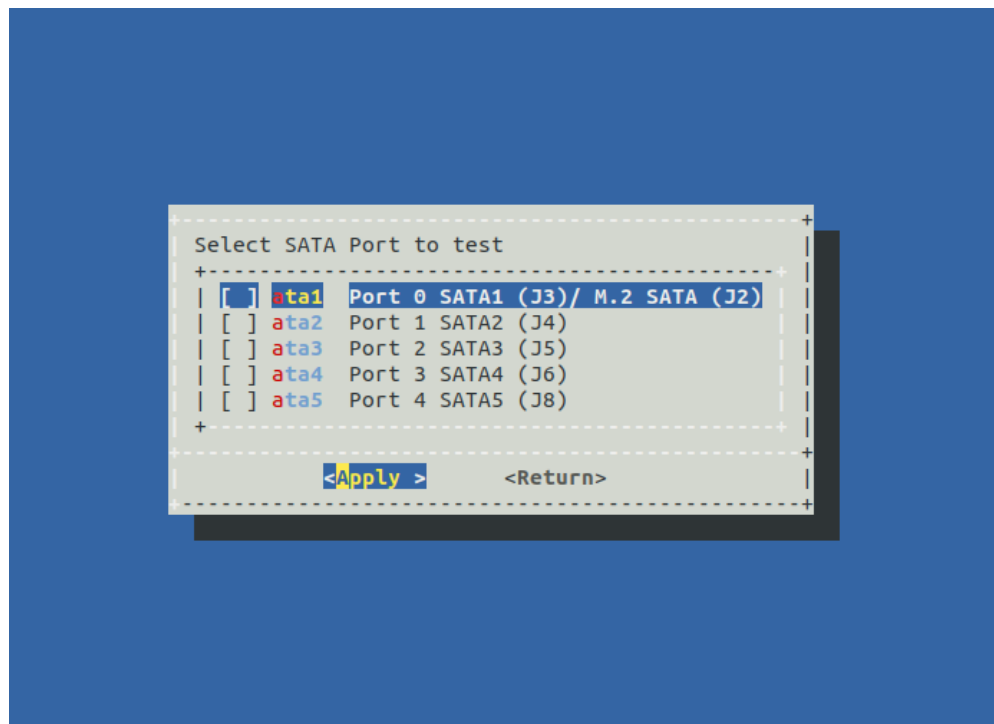

*Note: You will witness the blue LED5 blinking when SATA activity is ongoing.*

Run MicroSD test

Select **MicroSD** submenu. The test will start immediately.



Run eMMC test

Select **eMMC** submenu. The test will start immediately.

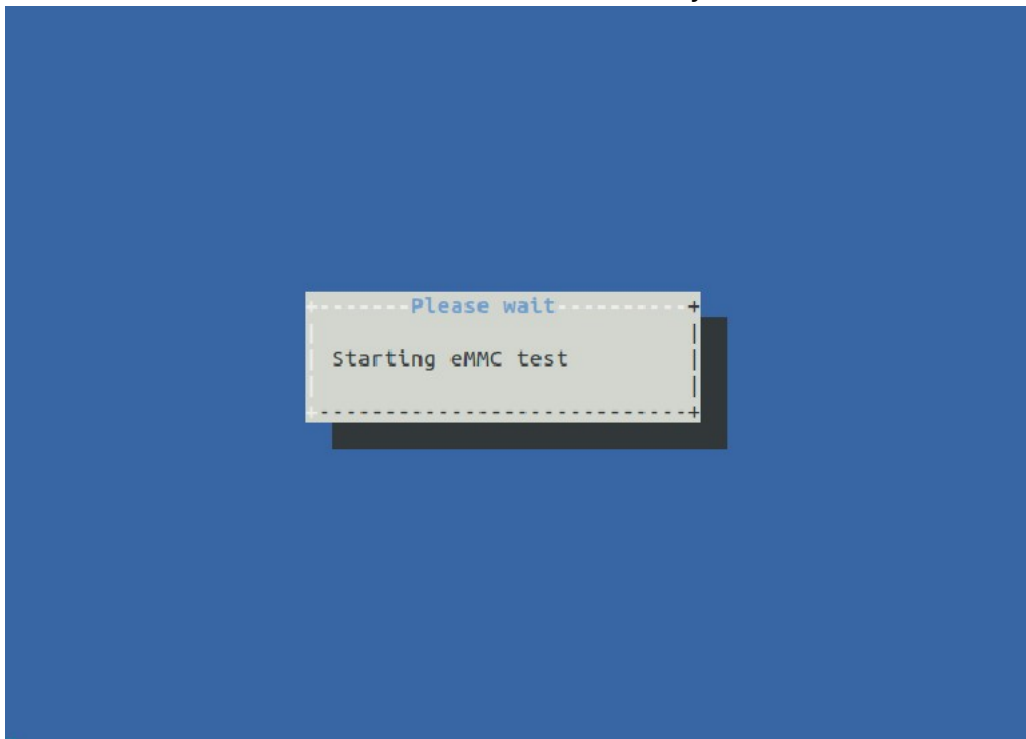

Run USB test

Select **USB** submenu, then select which USB port to test and press **Apply**.

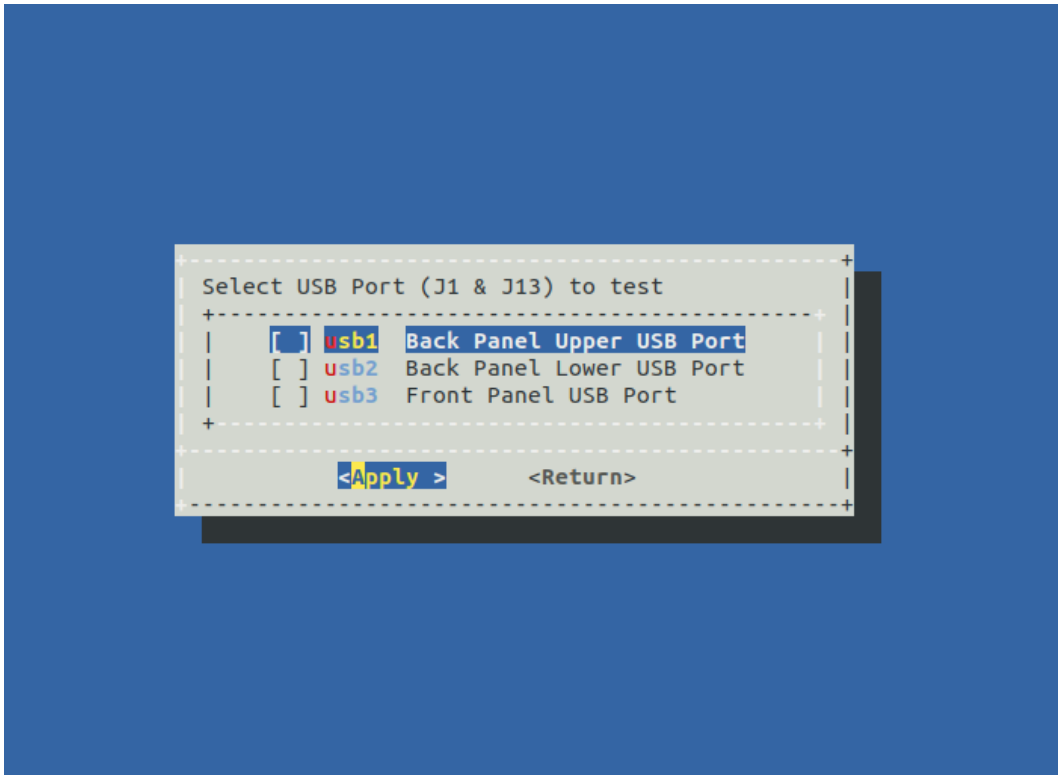

For USB Flash connected to Type-C, select **Type-C** submenu, then select *USB4* to test and press Apply.

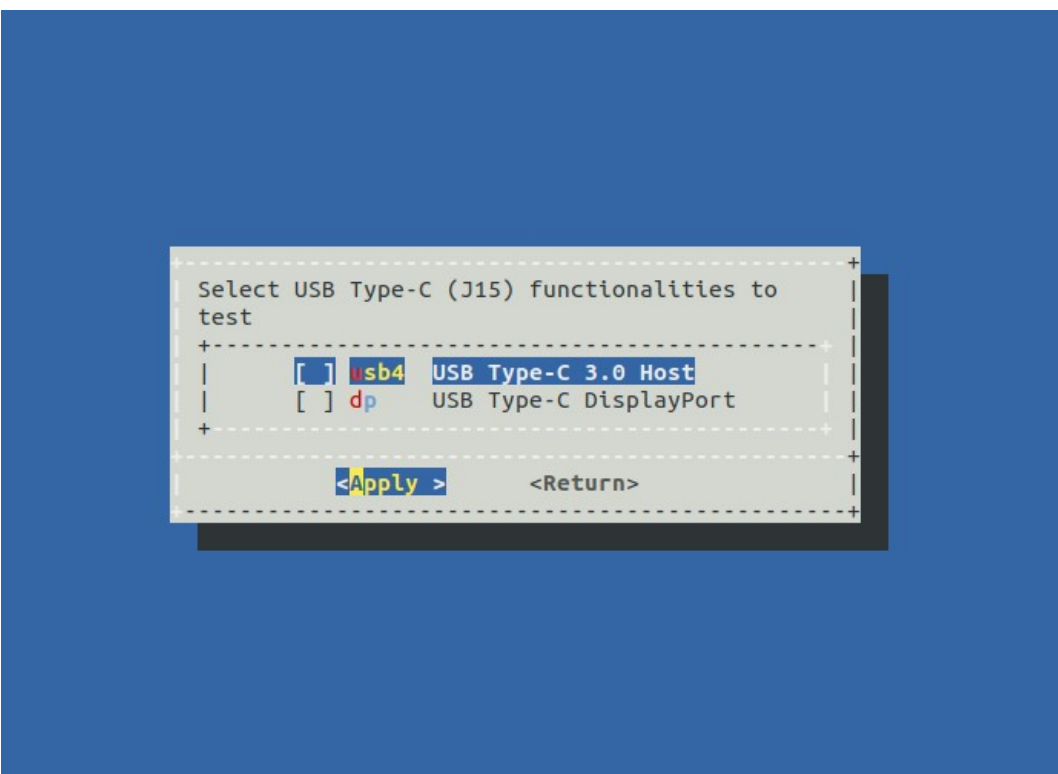





# Troubleshooting

## Troubleshooting table

Problem	Possible Cause	Solution
Cannot connect to Helios64	Faulty power supply	Verify whether LED1 is turned on. If it is not, tighten PSU cable.  If problem still occurs, replace the PSU.
	OS failure	Verify whether LED6 is blinking. If it is not, reset or power cycle.
	Network down	Verify whether Ethernet LED turned on. If it is not, try to unplug and plug the network cable.
	Wrong network configuration	Configure Test PC network as instructed in <a href="#">Network Config and Credentials</a> .
	Corrupt filesystem	Reflash the OS image as instructed in <a href="#">Writing an image to a microSD Card</a> .  If problem still occurs, replace the MicroSD card.
Cannot launch Helios64 Test application	Wrong software on microSD card	<a href="#">Check correct System Version is running</a> . If wrong version, reflash the OS image as instructed in <a href="#">Writing an image to a microSD Card</a> .
	Corrupt filesystem	Reflash the OS image as instructed in <a href="#">Writing an image to a microSD Card</a> .  If problem still occurs, replace the MicroSD card.

Cannot start test on one or more SATA Ports	SATA cable loose connection	<a href="#">Check whether all drives are detected</a> . Power off the system, tighten the SATA cable and power on.  If problem still occurs, replace the cable.
	Broken SATA drive	<a href="#">Check whether all drives are detected</a> . Replace the drive.
Cannot start test on one or more USB Ports	USB extension cable	<a href="#">Check whether all drives are detected</a> . Power off the system, tighten the USB cable and power on.  If problem still occurs, replace the cable.
	Broken USB drive	<a href="#">Check whether all drives are detected</a> . Replace the drive.
Helios64 system stops to respond	Network down	Verify whether Ethernet LED turned on. If it is not, try to unplug and plug the network cable.
	System crash/panic	Verify whether red LED7 is light up. If yes, reset or power cycle.

## Serial Console Access

1. Plug in Type-C to Type-A USB3.0 cable to Helios64 micro USB (J15) connector and the other end to Test PC.
2. Remove P13 Jumper if presents (Note: Don't forget to put it back when performing stress test).

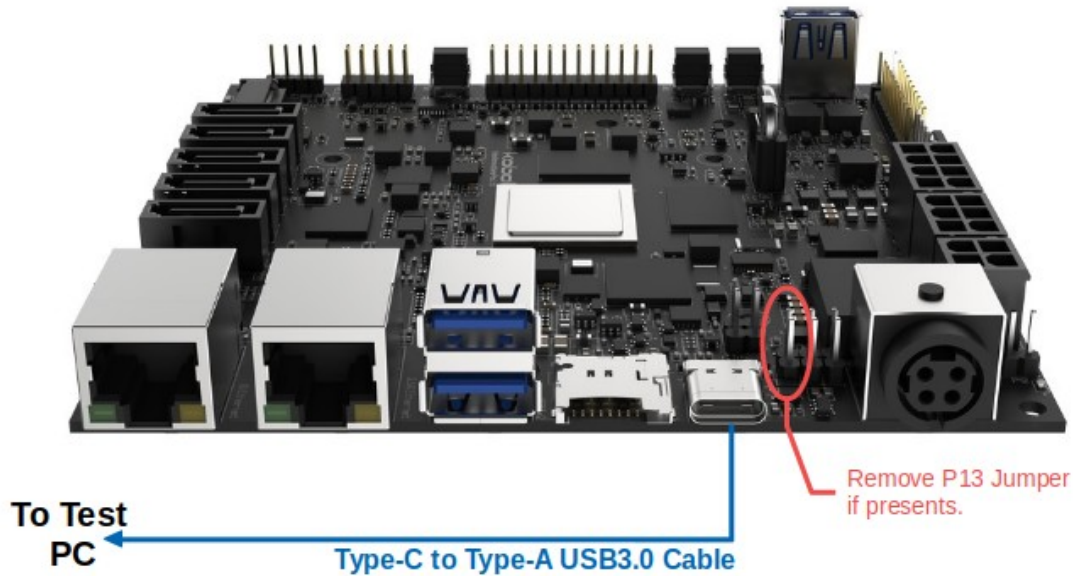

Under Windows

[Download Virtual COM Port \(VCP\) driver](#) and install. Open Device Manager, find *USB Serial Port* under “Ports (COM & LPT)”. Open *Properties* of the port.

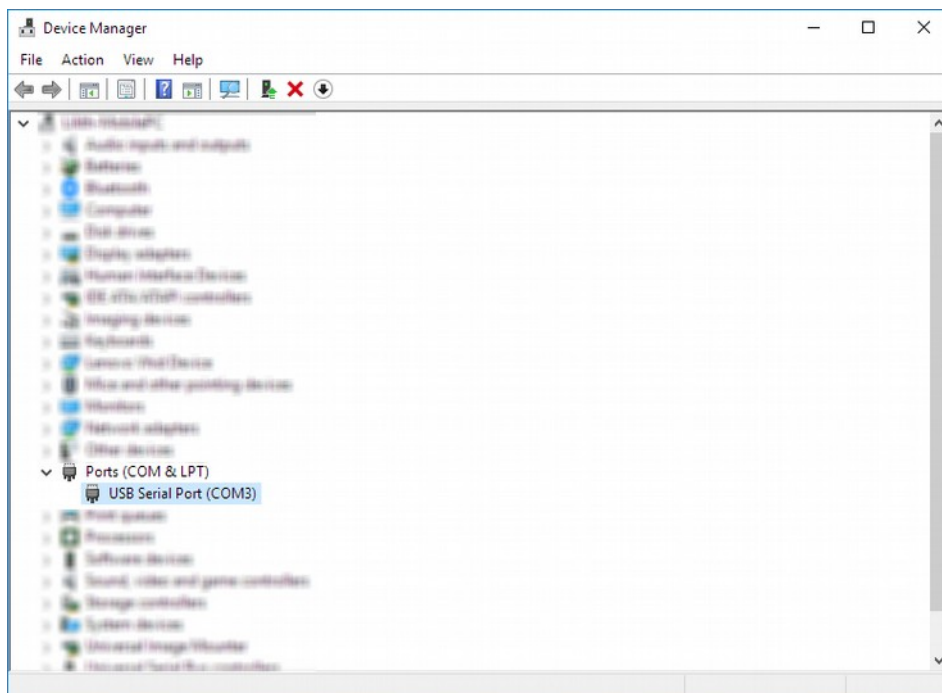

Verify that **FTDI** is the Manufacturer. Take note on the COM number.

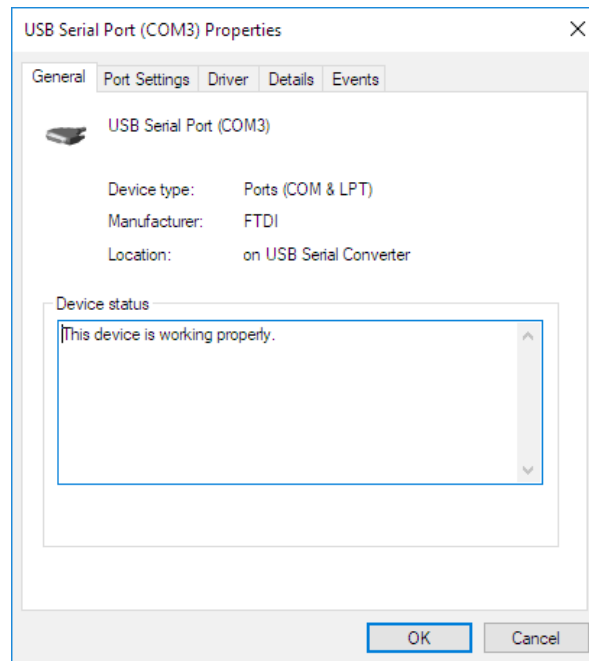

*Helios64 Serial Port assigned as COM3*

Run PuTTY from Start Menu. and setup the connection and press Open

Serial line	Assigned COM number in Device Manager
Speed	1500000
Connection type	Serial

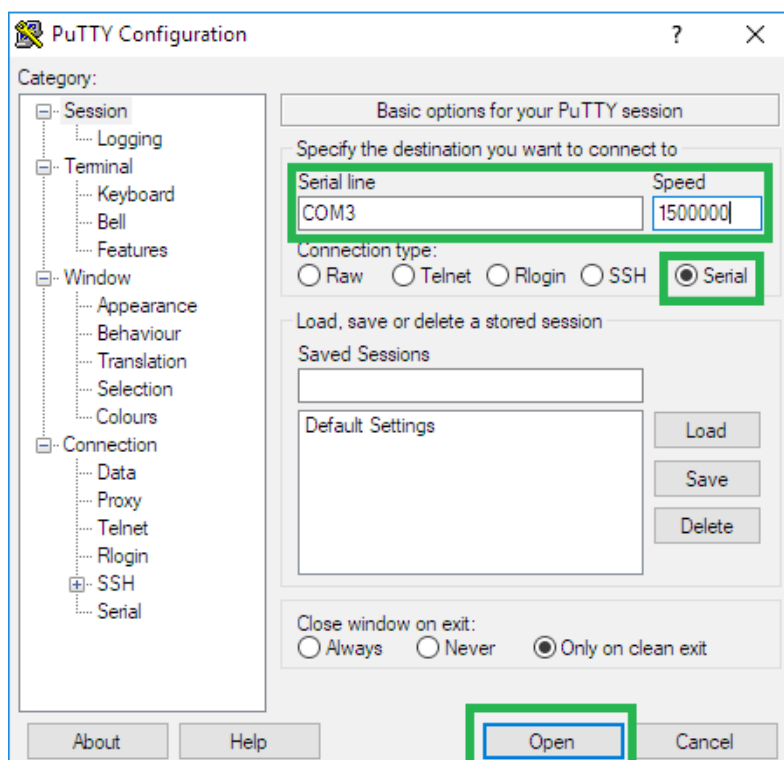

Under Linux (via Terminal)

Install picocom (under Debian/Ubuntu)

```
root@test-pc~# apt-get install picocom
```

Connect to serial (usually recognised as `/dev/ttyUSB0`) with picocom

```
root@helios64:~$ sudo picocom --b 1500000 /dev/ttyUSB0
picocom v2.2

port is          : /dev/ttyUSB0
flowcontrol     : none
baudrate is     : 1500000
parity is       : none
databits are    : 8
stopbits are    : 1
escape is       : C-a
local echo is   : no
noinit is      : no
noreset is     : no
nolock is      : no
send_cmd is    : sz -vv
receive_cmd is : rz -vv -E
imap is        :
omap is        :
emap is        : crclrf,delbs,

Type [C-a] [C-h] to see available commands

Terminal ready

Armbian 20.05.0-trunk Bionic ttyFIQ0

helios64 login: █
```

**Note:** To exit picocom do **Ctrl-a** then **Ctrl-x**

#### Login Credentials

Username	root
Password	root

## Troubleshooting commands

Check all drives are detected

```
root@helios64~# lsblk
```

You should see the following result:

NAME	MAJ:MIN	RM	SIZE	RO	TYPE	MOUNTPOINT
sda	8:0	0	111.8G	0	disk	
sdb	8:16	0	111.8G	0	disk	
sdc	8:32	0	111.8G	0	disk	
sdd	8:48	0	111.8G	0	disk	
sde	8:64	0	111.8G	0	disk	
sdf	8:80	1	28.7G	0	disk	
sdg	8:96	1	28.7G	0	disk	
sdh	8:112	1	28.7G	0	disk	
sdi	8:128	1	28.7G	0	disk	
mtdblock0	31:0	0	16M	0	disk	
mmcblk1	179:0	0	14.6G	0	disk	
mmcblk1boot0	179:32	0	4M	1	disk	
mmcblk1boot1	179:64	0	4M	1	disk	
mmcblk1rpmb	179:96	0	4M	0	disk	
mmcblk0	179:128	0	14.9G	0	disk	
└─mmcblk0p1	179:129	0	14.7G	0	part	/
zram0	251:0	0	50M	0	disk	/var/log
zram1	251:1	0	1G	0	disk	[SWAP]

5x SSD Drives

4x USB Flash Drives

On-Board eMMC Flash

MicroSD Card

Check IP address is correct

```
root@helios64~# ifconfig
```

You should see the following result:

```
root@helios64:~# ifconfig
eth0: flags=4163<UP,BROADCAST,RUNNING,MULTICAST> mtu 1500
    inet 10.10.0.1 netmask 255.255.255.0 broadcast 10.10.0.255
    inet6 fe80::10b5:bff:fea2:9be2 prefixlen 64 scopeid 0x20<link>
    ether 12:b5:0b:a2:9b:e2 txqueuelen 1000 (Ethernet)
    RX packets 2438 bytes 249122 (249.1 KB)
    RX errors 0 dropped 0 overruns 0 frame 0
    TX packets 173 bytes 30330 (30.3 KB)
    TX errors 0 dropped 0 overruns 0 carrier 0 collisions 0
    device interrupt 24

eth1: flags=4163<UP,BROADCAST,RUNNING,MULTICAST> mtu 1500
    inet 10.10.1.1 netmask 255.255.255.0 broadcast 10.10.1.255
    inet6 fe80::d4d0:36ff:fe5a:d9ab prefixlen 64 scopeid 0x20<link>
    ether d6:d0:36:5a:d9:ab txqueuelen 1000 (Ethernet)
    RX packets 2088 bytes 213292 (213.2 KB)
    RX errors 0 dropped 0 overruns 0 frame 0
    TX packets 68 bytes 6174 (6.1 KB)
    TX errors 0 dropped 0 overruns 0 carrier 0 collisions 0
```



Check correct System Version is running

- Check Kernel Build version

```
root@helios64~# uname -a
```

You should see the following result:

```
Linux helios64 4.4.213-rk3399 #26 SMP Wed Jun 17 01:41:54 WIB 2020 aarch64 aarch64 aarch64 GNU/Linux
```

- Check OS Build version

```
root@helios64~# cat /etc/armbian-release
```

You should see the following result:

```
# PLEASE DO NOT EDIT THIS FILE
BOARD=helios64
BOARD_NAME="Helios64"
BOARDFAMILY=rk3399
BUILD_REPOSITORY_URL=
BUILD_REPOSITORY_COMMIT=a7d1816c7-dirty
DISTRIBUTION_CODENAME=bionic
DISTRIBUTION_STATUS=supported
VERSION=20.05.0-trunk
LINUXFAMILY=rk3399
BRANCH=legacy
ARCH=arm64
IMAGE_TYPE=user-built
BOARD_TYPE=wip
INITRD_ARCH=arm64
KERNEL_IMAGE_TYPE=Image
```

- Check Helios64 Test Suite version

```
root@helios64~# helios64_test -v
```

You should see the following result:

```
Helios64 Test Suite - Version 0.2
```

## Boot Screen

### U-Boot

```
U-Boot TPL 2020.04-armbian (Jun 17 2020 - 01:19:53)
Channel 0: LPDDR4, 50MHz
BW=32 Col=10 Bk=8 CS0 Row=16/15 CS=1 Die BW=16 Size=2048MB
Channel 1: LPDDR4, 50MHz
BW=32 Col=10 Bk=8 CS0 Row=16/15 CS=1 Die BW=16 Size=2048MB
256B stride
256B stride
lpddr4_set_rate: change freq to 400000000 mhz 0, 1
lpddr4_set_rate: change freq to 800000000 mhz 1, 0
Trying to boot from BOOTROM
Returning to boot ROM...

U-Boot SPL 2020.04-armbian (Jun 17 2020 - 01:19:53 +0700)
Trying to boot from MMC1
NOTICE: BL31: v1.3(debug):42583b6
NOTICE: BL31: Built : 07:55:13, Oct 15 2019
NOTICE: BL31: Rockchip release version: v1.1
INFO: GICv3 with legacy support detected. ARM GICV3 driver initialized in
EL3
INFO: Using opteed sec cpu_context!
INFO: boot cpu mask: 0
INFO: If lpddr4 need support multi frequency,
INFO: please update loader!
INFO: Current ctl index[0] freq=400MHz
INFO: Current ctl index[1] freq=800MHz
INFO: plat_rockchip_pmu_init(1190): pd status 3e
INFO: BL31: Initializing runtime services
WARNING: No OPTEE provided by BL2 boot loader, Booting device without OPTEE
initialization. SMC's destined for OPTEE will return SMC_UNK
ERROR: Error initializing runtime service opteed_fast
INFO: BL31: Preparing for EL3 exit to normal world
INFO: Entry point address = 0x200000
INFO: SPSR = 0x3c9

U-Boot 2020.04-armbian (Jun 17 2020 - 01:19:53 +0700)

SoC: Rockchip rk3399
Reset cause: POR
DRAM: 3.9 GiB
PMIC: RK808
SF: Detected w25q128 with page size 256 Bytes, erase size 4 KiB, total 16 MiB
Invalid board ID data!
MMC: dwmmc@fe320000: 1, sdhci@fe330000: 0
Loading Environment from MMC... *** Warning - bad CRC, using default
environment

In: serial
Out: serial
Err: serial
Model: Helios64
Revision: UNKNOWN
Net: eth0: ethernet@fe300000
Hit any key to stop autoboot: 0
```

```
switch to partitions #0, OK
mmc1 is current device
Scanning mmc 1:1...
Found U-Boot script /boot/boot.scr
2940 bytes read in 6 ms (478.5 KiB/s)
## Executing script at 00500000
Boot script loaded from mmc 1
208 bytes read in 5 ms (40 KiB/s)
11128366 bytes read in 476 ms (22.3 MiB/s)
23248904 bytes read in 987 ms (22.5 MiB/s)
101964 bytes read in 12 ms (8.1 MiB/s)
## Loading init Ramdisk from Legacy Image at 06000000 ...
   Image Name:   uInitrd
   Image Type:   AArch64 Linux RAMDisk Image (gzip compressed)
   Data Size:    11128302 Bytes = 10.6 MiB
   Load Address: 00000000
   Entry Point:  00000000
   Verifying Checksum ... OK
## Flattened Device Tree blob at 01f00000
   Booting using the fdt blob at 0x1f00000
   Loading Ramdisk to f5458000, end f5ef4dee ... OK
ERROR: reserving fdt memory region failed (addr=0 size=0)
   Loading Device Tree to 00000000f53d6000, end 00000000f5457fff ... OK

Starting kernel ...
```

# Linux

```
Starting kernel ...

[ 0.000000] Booting Linux on physical CPU 0x0
[ 0.000000] Initializing cgroup subsys cpuset
[ 0.000000] Initializing cgroup subsys cpu
[ 0.000000] Initializing cgroup subsys cpucact
[ 0.000000] Linux version 4.4.213-rk3399 (root@KOBOL-DEV) (gcc version 8.3.0 (GNU Toolchain for the A-profile Architecture 8.3-2019.03 (arm-rel-8.36))) #26 SMP Wed Jun 17 01:41:54 WIB 2020
[ 0.000000] Boot CPU: AArch64 Processor [410fd034]
[ 0.000000] Reserved memory: failed to reserve memory for node 'drm-logo@00000000': base 0x0000000000000000, size 0 MiB
[ 0.000000] psci: probing for conduit method from DT.
[ 0.000000] psci: PSCIv1.0 detected in firmware.
[ 0.000000] psci: Using standard PSCI v0.2 function IDs
[ 0.000000] psci: MIGRATE_INFO_TYPE not supported.
[ 0.000000] psci: SMC Calling Convention v1.0
[ 0.000000] PERCPU: Embedded 20 pages/cpu @ffffc0f7ed2000 s42280 r8192 d31448 u81920
[ 0.000000] Detected VIPT I-cache on CPU0
[ 0.000000] CPU features: enabling workaround for ARM erratum 845719
[ 0.000000] Built 1 zonelists in Zone order, mobility grouping on. Total pages: 999432
[ 0.000000] Kernel command line: root=UUID=6dbfa903-0ec9-4186-af7e-f110ccf13e93 rootwait rootfstype=ext4 console=ttyS2,1500000 console=tty1 consoleblank=0 loglevel=7 ubootpart=d3f6b55c-01 usb-storage.quirks=0x2537:0x1066:u,0x2537:0x1068:u cgroup_enable=cpuset cgroup_memory=1 cgroup_enable=memory swapaccount=1
[ 0.000000] PID hash table entries: 4096 (order: 3, 32768 bytes)
[ 0.000000] Dentry cache hash table entries: 524288 (order: 10, 4194304 bytes)
[ 0.000000] Inode-cache hash table entries: 262144 (order: 9, 2097152 bytes)
[ 0.000000] software IO TLB: mapped [mem 0xee800000-0xf2800000] (64MB)
[ 0.000000] Memory: 3886644K/4061184K available (11518K kernel code, 1392K rwdata, 6044K rodata, 3712K init, 1957K bss, 174540K reserved, 0K cma-reserved)
[ 0.000000] Virtual kernel memory layout:
[ 0.000000]   modules : 0xffff800000000000 - 0xffff800800000000 ( 128 MB)
[ 0.000000]   vmalloc : 0xffff800800000000 - 0xffffbdf000000000 ( 246 GB)
[ 0.000000]   .init : 0xffff80091b000000 - 0xffff800955000000 ( 3712 KB)
[ 0.000000]   .text : 0xffff800808000000 - 0xffff8008bc000000 ( 11520 KB)
[ 0.000000]   .rodata : 0xffff8008bc000000 - 0xffff80091b000000 ( 6080 KB)
[ 0.000000]   .data : 0xffff800955000000 - 0xffff80096ac008 ( 1393 KB)
[ 0.000000]   vmemmap : 0xffffbdc000000000 - 0xffffbfc000000000 ( 8 GB maximum)
[ 0.000000]             0xffffbdc000800000 - 0xffffbdc3e0000000 ( 61 MB actual)
[ 0.000000]   fixed : 0xffffbffe7fb00000 - 0xffffbffe00000000 ( 4116 KB)
[ 0.000000]   PCI I/O : 0xffffbffe00000000 - 0xffffbffe00000000 ( 16 MB)
[ 0.000000]   memory : 0xfffffc0002000000 - 0xfffffc0f80000000 ( 3966 MB)
[ 0.000000] SLUB: HWalign=64, Order=0-3, MinObjects=0, CPUs=6, Nodes=1
[ 0.000000] Hierarchical RCU implementation.
[ 0.000000]   Build-time adjustment of leaf fanout to 64.
[ 0.000000]   RCU restricting CPUs from NR_CPUS=8 to nr_cpu_ids=6.
[ 0.000000] RCU: Adjusting geometry for rcu_fanout_leaf=64, nr_cpu_ids=6
[ 0.000000] NR_IRQS:64 nr_irqs:64 0
[ 0.000000] GIC: Using split EOI/Deactivate mode
[ 0.000000] ITS: /interrupt-controller@fee00000/interrupt-controller@fee20000
[ 0.000000] ITS: allocated 65536 Devices @ee500000 (psz 64K, shr 0)
[ 0.000000] ITS: using cache flushing for cmd queue
[ 0.000000] GIC: using LPI property table @0x00000000ee490000
[ 0.000000] ITS: Allocated 1792 chunks for LPIs
[ 0.000000] CPU0: found redistributor 0 region 0:0x00000000fef00000
[ 0.000000] CPU0: using LPI pending table @0x00000000ee4a0000
[ 0.000000] GIC: using cache flushing for LPI property table
[ 0.000000] GIC: PPI partition interrupt-partition-0[0] { /cpus/cpu@0[0] /cpus/cpu@1[1] /cpus/cpu@2[2] /cpus/cpu@3[3] }
[ 0.000000] GIC: PPI partition interrupt-partition-1[1] { /cpus/cpu@100[4] /cpus/cpu@101[5] }
[ 0.000000] rockchip_clk_register_frac_branch: could not find dclk_vop0_frac as parent of dclk_vop0, rate changes may not work
[ 0.000000] rockchip_clk_register_frac_branch: could not find dclk_vop1_frac as parent of dclk_vop1, rate changes may not work
[ 0.000000] Architected cp15 timer(s) running at 24.00MHz (phys).
[ 0.000000] clocksource: arch_sys_counter: mask: 0xfffffffffff max_cycles: 0x588fe9dc0, max_idle_ns: 440795202592 ns
[ 0.000006] sched_clock: 56 bits at 24MHz, resolution 41ns, wraps every 4398046511097ns
[ 0.001557] Console: colour dummy device 80x25
[ 0.003491] console [tty1] enabled
[ 0.016816] Calibrating delay loop (skipped), value calculated using timer frequency.. 48.00 BogoMIPS (lpj=96000)
[ 0.016899] pid_max: default: 32768 minimum: 301
[ 0.017302] Security Framework initialized
[ 0.017339] Yama: becoming mindful.
[ 0.017408] AppArmor: AppArmor disabled by boot time parameter
[ 0.017651] Mount-cache hash table entries: 8192 (order: 4, 65536 bytes)
[ 0.017695] Mountpoint-cache hash table entries: 8192 (order: 4, 65536 bytes)
[ 0.019588] Initializing cgroup subsys io
[ 0.019639] Initializing cgroup subsys memory
[ 0.019755] Initializing cgroup subsys devices
[ 0.019802] Initializing cgroup subsys freezer
[ 0.019847] Initializing cgroup subsys net_cls
[ 0.019891] Initializing cgroup subsys perf_event
[ 0.019958] Initializing cgroup subsys net_prio
[ 0.020008] Initializing cgroup subsys hugetlb
[ 0.020051] Initializing cgroup subsys pids
[ 0.020175] ftrace: allocating 41387 entries in 162 pages
[ 0.132098] sched-energy: Sched-energy-costs installed from DT
[ 0.132149] CPU0: update cpu_capacity 401
[ 0.132253] ASID allocator initialised with 32768 entries
[ 0.136953] PCI/MSI: /interrupt-controller@fee00000/interrupt-controller@fee20000 domain created
[ 0.137614] Platform MSI: /interrupt-controller@fee00000/interrupt-controller@fee20000 domain created
[ 0.139606] Detected VIPT I-cache on CPU1
[ 0.139636] CPU1: found redistributor 1 region 0:0x00000000fef20000
[ 0.139666] CPU1: using LPI pending table @0x00000000edcf0000
[ 0.139712] CPU1: update cpu_capacity 401
[ 0.139716] CPU1: Booted secondary processor [410fd034]
[ 0.140538] Detected VIPT I-cache on CPU2
[ 0.140558] CPU2: found redistributor 2 region 0:0x00000000fef40000
[ 0.140585] CPU2: using LPI pending table @0x00000000edd20000
```

```

[ 0.140613] CPU2: update cpu_capacity 401
[ 0.140616] CPU2: Booted secondary processor [410fd034]
[ 0.141421] Detected VIPT I-cache on CPU3
[ 0.141440] CPU3: found redistributor 3 region 0:0x00000000fef60000
[ 0.141468] CPU3: using LPI pending table @0x00000000edd80000
[ 0.141495] CPU3: update cpu_capacity 401
[ 0.141498] CPU3: Booted secondary processor [410fd034]
[ 0.142312] Detected PIPT I-cache on CPU4
[ 0.142338] CPU4: found redistributor 100 region 0:0x00000000fef80000
[ 0.142378] CPU4: using LPI pending table @0x00000000eddc0000
[ 0.142415] CPU4: update cpu_capacity 1024
[ 0.142419] CPU4: Booted secondary processor [410fd082]
[ 0.143527] Detected PIPT I-cache on CPU5
[ 0.143544] CPU5: found redistributor 101 region 0:0x00000000fefa0000
[ 0.143580] CPU5: using LPI pending table @0x00000000eddf0000
[ 0.143607] CPU5: update cpu_capacity 1024
[ 0.143610] CPU5: Booted secondary processor [410fd082]
[ 0.143698] Brought up 6 CPUs
[ 0.144419] SMP: Total of 6 processors activated.
[ 0.144453] CPU features: detected feature: GIC system register CPU interface
[ 0.144490] CPU features: detected feature: 32-bit EL0 Support
[ 0.144526] CPU: All CPU(s) started at EL2
[ 0.144600] alternatives: patching kernel code
[ 0.147829] devtmpfs: initialized
[ 0.217932] clocksource: jiffies: mask: 0xffffffff max_cycles: 0xffffffff, max_idle_ns: 7645041785100000 ns
[ 0.217998] futex hash table entries: 2048 (order: 5, 131072 bytes)
[ 0.218696] xor: measuring software checksum speed
[ 0.254863] 8regs : 2850.000 MB/sec
[ 0.294923] 8regs_prefetch: 2556.000 MB/sec
[ 0.334985] 32regs : 3202.000 MB/sec
[ 0.375047] 32regs_prefetch: 2840.000 MB/sec
[ 0.375069] xor: using function: 32regs (3202.000 MB/sec)
[ 0.375152] pinctrl core: initialized pinctrl subsystem
[ 0.377552] Failed to find legacy iommu devices
[ 0.378395] NET: Registered protocol family 16
[ 0.390888] cpuidle: using governor ladder
[ 0.400029] cpuidle: using governor menu
[ 0.400100] Registered FIQ tty driver
[ 0.400459] vds0: 2 pages (1 code @ fffff8008bc6000, 1 data @ fffff8009555000)
[ 0.400523] hw-breakpoint: found 6 breakpoint and 4 watchpoint registers.
[ 0.400742] DMA: preallocated 256 KiB pool for atomic allocations
[ 0.447787] console [pstore-1] enabled
[ 0.447816] pstore: Registered ramoops as persistent store backend
[ 0.447840] ramoops: attached 0xf0000@0x110000, ecc: 0/0
[ 0.527649] console [ttyFIQ0] enabled
[ 0.528460] Registered fiq debugger ttyFIQ0
[ 0.627490] raid6: int64x1 gen() 451 MB/s
[ 0.695582] raid6: int64x1 xor() 388 MB/s
[ 0.763703] raid6: int64x2 gen() 794 MB/s
[ 0.831767] raid6: int64x2 xor() 599 MB/s
[ 0.899868] raid6: int64x4 gen() 970 MB/s
[ 0.968001] raid6: int64x4 xor() 673 MB/s
[ 1.036122] raid6: int64x8 gen() 807 MB/s
[ 1.104215] raid6: int64x8 xor() 608 MB/s
[ 1.172336] raid6: neonx1 gen() 924 MB/s
[ 1.240414] raid6: neonx1 xor() 650 MB/s
[ 1.308513] raid6: neonx2 gen() 1578 MB/s
[ 1.376638] raid6: neonx2 xor() 992 MB/s
[ 1.444740] raid6: neonx4 gen() 2087 MB/s
[ 1.512824] raid6: neonx4 xor() 1153 MB/s
[ 1.580925] raid6: neonx8 gen() 1696 MB/s
[ 1.649048] raid6: neonx8 xor() 1256 MB/s
[ 1.649446] raid6: using algorithm neonx4 gen() 2087 MB/s
[ 1.649941] raid6: .... xor() 1153 MB/s, rmw enabled
[ 1.650399] raid6: using intx1 recovery algorithm
[ 1.653386] vcc12v_dcin_bkup: supplied by vcc12v_dcin
[ 1.654587] vcc12v_hdd: supplied by vcc12v_dcin_bkup
[ 1.656000] vcc1v8_sys_s0: regulator get failed, ret=-517
[ 1.657062] vcc0v9_s3: regulator get failed, ret=-517
[ 1.658087] avdd_0v9_s0: regulator get failed, ret=-517
[ 1.659208] avdd_1v8_s0: regulator get failed, ret=-517
[ 1.670488] pcie_power: regulator get failed, ret=-517
[ 1.671708] vcc3v3_sys_s3: regulator get failed, ret=-517
[ 1.694365] vcc3v0_sd: regulator get failed, ret=-517
[ 1.695961] vcc5v0_usb: regulator get failed, ret=-517
[ 1.697081] vcc5v0_perdev: supplied by vcc12v_dcin_bkup
[ 1.698334] pcie_power: supplied by vcc5v0_perdev
[ 1.699023] vcc5v0_usb: supplied by vcc5v0_perdev
[ 1.699708] vcc5v0_hdd: supplied by vcc12v_dcin_bkup
[ 1.701162] vcc5v0_sys: supplied by vcc12v_dcin_bkup
[ 1.702234] vcc3v3_sys_s3: supplied by vcc5v0_sys
[ 1.702732] vcc0v9_s3: supplied by vcc3v3_sys_s3
[ 1.703305] avdd_1v8_s0: supplied by vcc3v3_sys_s3
[ 1.703854] vcc3v0_sd: supplied by vcc3v3_sys_s3
[ 5.722079] usblan_power: supplied by vcc5v0_usb
[ 5.724039] iommu: Adding device ff650000.vpu_service to group 0
[ 5.724725] iommu: Adding device ff600000.rkvdec to group 1
[ 5.725447] iommu: Adding device ff8f0000.vop to group 2
[ 5.726070] iommu: Adding device ff900000.vop to group 3
[ 5.727225] rk_iommu ff650800.iommu: can't get sclk
[ 5.728084] rk_iommu ff604800.iommu: can't get sclk
[ 5.728839] rk_iommu ff8f3f00.iommu: can't get sclk
[ 5.729570] rk_iommu ff903f00.iommu: can't get sclk
[ 5.731038] SCSI subsystem initialized
[ 5.732481] usbcore: registered new interface driver usbfs
[ 5.733154] usbcore: registered new interface driver hub
[ 5.733865] usbcore: registered new device driver usb
[ 5.734682] media: Linux media interface: v0.10
[ 5.735264] Linux video capture interface: v2.00

```

```

[ 5.736106] pps_core: LinuxPPS API ver. 1 registered
[ 5.736576] pps_core: Software ver. 5.3.6 - Copyright 2005-2007 Rodolfo Giometti <giometti@linux.it>
[ 5.737479] PTP clock support registered
[ 5.741023] Advanced Linux Sound Architecture Driver Initialized.
[ 5.744483] NetLabel: Initializing
[ 5.744820] NetLabel: domain hash size = 128
[ 5.745248] NetLabel: protocols = UNLABELED CIPSOv4
[ 5.745857] NetLabel: unlabeled traffic allowed by default
[ 5.746985] rockchip-cpuinfo cpuinfo: Serial : 42fb50b5ba3c936c
[ 5.748294] clocksource: Switched to clocksource arch_sys_counter
[ 5.851553] thermal thermal_zone1: power_allocator: sustainable_power will be estimated
[ 5.853188] NET: Registered protocol family 2
[ 5.854515] TCP established hash table entries: 32768 (order: 6, 262144 bytes)
[ 5.855444] TCP bind hash table entries: 32768 (order: 8, 1048576 bytes)
[ 5.856884] TCP: Hash tables configured (established 32768 bind 32768)
[ 5.857634] UDP hash table entries: 2048 (order: 5, 196608 bytes)
[ 5.858343] UDP-Lite hash table entries: 2048 (order: 5, 196608 bytes)
[ 5.859677] NET: Registered protocol family 1
[ 5.861508] Trying to unpack rootfs image as initramfs...
[ 6.431776] Freeing initrd memory: 10864K
[ 6.432780] hw perfevents: enabled with armv8_cortex_a53 PMU driver, 7 counters available
[ 6.433717] hw perfevents: enabled with armv8_cortex_a72 PMU driver, 7 counters available
[ 6.440245] audit: initializing netlink subsys (disabled)
[ 6.440876] audit: type=2000 audit(6.360:1): initialized
[ 6.442384] Initialise system trusted keyring
[ 6.443444] HugeTLB registered 2 MB page size, pre-allocated 0 pages
[ 6.467887] VFS: Disk quotas dquot_6.6.0
[ 6.469389] VFS: Dquot-cache hash table entries: 512 (order 0, 4096 bytes)
[ 6.474353] squashfs: version 4.0 (2009/01/31) Phillip Lougher
[ 6.477498] fuse init (API version 7.23)
[ 6.479595] JFS: nTxBlock = 8192, nTxLock = 65536
[ 6.486235] SGI XFS with ACLs, security attributes, realtime, no debug enabled
[ 6.491539] Key type big_key registered
[ 6.491922]
[ 6.491922] TEE Core Framework initialization (ver 1:0.1)
[ 6.492762] TEE armv7 Driver initialization
[ 6.493832] tz_tee_probe: name="armv7sec", id=0, pdev_name="armv7sec.0"
[ 6.494441] TEE core: Alloc the misc device "opteearmtz00" (id=0)
[ 6.495415] TEE Core: Register the misc device "opteearmtz00" (id=0,minor=62)
[ 6.503547] Key type asymmetric registered
[ 6.503945] Asymmetric key parser 'x509' registered
[ 6.504931] Block layer SCSI generic (bsg) driver version 0.4 loaded (major 244)
[ 6.505832] io scheduler noop registered
[ 6.506213] io scheduler deadline registered (default)
[ 6.506744] io scheduler cfq registered
[ 6.509794] phy phy-ff770000.syscon:usb2-phy@e460.1: Failed to get VBUS supply regulator
[ 6.521829] rk-vcodect ff650000.vpu_service: no regulator for vcodect
[ 6.522760] rk-vcodect ff650000.vpu_service: probe device
[ 6.523660] rk-vcodect ff650000.vpu_service: drm allocator with mmu enabled
[ 6.525614] rk-vcodect ff650000.vpu_service: could not find power_model node
[ 6.526256] rk-vcodect ff650000.vpu_service: init success
[ 6.527083] rk-vcodect ff660000.rkvdec: no regulator for vcodect
[ 6.528157] rk-vcodect ff660000.rkvdec: probe device
[ 6.529016] rk-vcodect ff660000.rkvdec: drm allocator with mmu enabled
[ 6.530313] rk-vcodect ff660000.rkvdec: could not find power_model node
[ 6.530906] rk-vcodect ff660000.rkvdec: init success
[ 6.534882] dma-pl330 ff6d0000.dma-controller: Loaded driver for PL330 DMAC-241330
[ 6.535586] dma-pl330 ff6d0000.dma-controller: DBUFF-32x8bytes Num_Chans-6 Num_Per1-12 Num_Events-12
[ 6.541195] dma-pl330 ff6e0000.dma-controller: Loaded driver for PL330 DMAC-241330
[ 6.541900] dma-pl330 ff6e0000.dma-controller: DBUFF-128x8bytes Num_Chans-8 Num_Per1-20 Num_Events-16
[ 6.544257] rockchip-system-monitor rockchip-system-monitor: system monitor probe
[ 6.547368] Serial: 8250/16550 driver, 5 ports, IRQ sharing disabled
[ 6.549775] [drm] Initialized drm 1.1.0 20060810
[ 6.554259] [drm] Rockchip DRM driver version: v1.0.1
[ 6.558187] Unable to detect cache hierarchy for CPU 0
[ 6.560588] brd: module loaded
[ 6.576085] loop: module loaded
[ 6.577311] lkdtm: No crash points registered, enable through debugfs
[ 6.580055] rockchip-spi ff1d0000.spi: no high_speed pinctrl state
[ 6.581804] m25p80 spi0.0: w25q128 (16384 Kbytes)
[ 6.585176] rockchip-spi ff1e0000.spi: no high_speed pinctrl state
[ 6.586832] rockchip-spi ff200000.spi: no high_speed pinctrl state
[ 6.590527] rk_gmac-dwmac fe300000.ethernet: clock input or output? (input).
[ 6.591173] rk_gmac-dwmac fe300000.ethernet: TX delay(0x28).
[ 6.591695] rk_gmac-dwmac fe300000.ethernet: RX delay(0x20).
[ 6.592230] rk_gmac-dwmac fe300000.ethernet: integrated PHY? (no).
[ 6.593015] rk_gmac-dwmac fe300000.ethernet: cannot get clock clk_mac_speed
[ 6.593653] rk_gmac-dwmac fe300000.ethernet: clock input from PHY
[ 6.599213] rk_gmac-dwmac fe300000.ethernet: init for RGMII
[ 6.599907] stmmac - user ID: 0x10, Synopsys ID: 0x35
[ 6.600453] Ring mode enabled
[ 6.600739] DMA HW capability register supported
[ 6.601142] Normal descriptors
[ 6.601474] RX Checksum Offload Engine supported (type 2)
[ 6.601979] TX Checksum insertion supported
[ 6.602368] Wake-Up On Lan supported
[ 6.602972] Enable RX Mitigation via HW Watchdog Timer
[ 6.682400] libphy: stmmac: probed
[ 6.682742] eth%d: PHY ID 001cc916 at 0 IRQ POLL (stmmac-0:00) active
[ 6.683333] eth%d: PHY ID 001cc916 at 1 IRQ POLL (stmmac-0:01)
[ 6.686107] usbcore: registered new interface driver rndis_wlan
[ 6.687127] Rockchip WiFi SYS interface (V1.00) ...
[ 6.687852] usbcore: registered new interface driver cdc_ether
[ 6.688550] usbcore: registered new interface driver rndis_host
[ 6.691893] rockchip-dwc3 usb0: failed to get drvdata dwc3
[ 6.698368] rockchip-dwc3 usb1: fail to get drvdata hcd
[ 6.701275] ehci_hcd: USB 2.0 'Enhanced' Host Controller (EHCI) Driver
[ 6.701921] ehci-pci: EHCI PCI platform driver
[ 6.702490] ehci-platform: EHCI generic platform driver

```

```

[ 6.703936] ohci_hcd: USB 1.1 'Open' Host Controller (OHC) Driver
[ 6.704597] ohci-platform: OHCI generic platform driver
[ 6.706678] usbcore: registered new interface driver cdc_acm
[ 6.707210] cdc_acm: USB Abstract Control Model driver for USB modems and ISDN adapters
[ 6.708089] usbcore: registered new interface driver cdc_wdm
[ 6.708931] usbcore: registered new interface driver usbserial
[ 6.709573] usbcore: registered new interface driver usbserial_generic
[ 6.710256] usbserial: USB Serial support registered for generic
[ 6.712555] usbcore: registered new interface driver iforce
[ 6.713188] usbcore: registered new interface driver xpad
[ 6.714140] usbcore: registered new interface driver usbtouchscreen
[ 6.714717] <<-GTP-INFO->> GTP driver installing
[ 6.715757] sensor_register_slave:mma8452,id=17
[ 6.716183] sensor_register_slave:lis3dh,id=7
[ 6.716646] sensor_register_slave:mma7660,id=18
[ 6.717070] sensor_register_slave:lsm303d,id=22
[ 6.717494] sensor_register_slave:mpu6880_acc,id=24
[ 6.717952] sensor_register_slave:mpu6500_acc,id=25
[ 6.718409] sensor_register_slave:lsm330_acc,id=26
[ 6.718856] sensor_register_slave:akm8975,id=30
[ 6.719279] sensor_register_slave:akm8963,id=31
[ 6.719702] sensor_register_slave:l3g4200d,id=45
[ 6.720136] sensor_register_slave:l3g20d,id=46
[ 6.720568] sensor_register_slave:ewtsa,id=47
[ 6.720980] sensor_register_slave:lsm330_gyro,id=51
[ 6.721437] sensor_register_slave:cm3217,id=53
[ 6.721860] sensor_register_slave:cm3218,id=54
[ 6.723075] i2c /dev entries driver
[ 6.725503] rk808 0-001b: Pmic Chip id: 0x0
[ 6.729244] rk808-regulator rk808-regulator: there is no dvs0 gpio
[ 6.729872] rk808-regulator rk808-regulator: there is no dvs1 gpio
[ 6.730580] DCDC_REG1: supplied by vcc5v0_sys
[ 6.732232] DCDC_REG2: supplied by vcc5v0_sys
[ 6.733876] DCDC_REG3: supplied by vcc5v0_sys
[ 6.735004] DCDC_REG4: supplied by vcc5v0_sys
[ 6.736189] vcc1v8_sys_s0: supplied by vcc1v8_sys_s3
[ 6.736769] avdd_0v9_s0: supplied by vcc1v8_sys_s3
[ 6.737410] LDO_REG1: supplied by vcc5v0_sys
[ 6.738812] LDO_REG2: supplied by vcc5v0_sys
[ 6.740069] LDO_REG3: supplied by vcc5v0_sys
[ 6.741964] LDO_REG4: supplied by vcc5v0_sys
[ 6.743746] LDO_REG5: supplied by vcc5v0_sys
[ 6.744998] LDO_REG6: supplied by vcc5v0_sys
[ 6.746767] LDO_REG7: supplied by vcc5v0_sys
[ 6.748029] LDO_REG8: supplied by vcc5v0_sys
[ 6.749830] SWITCH_REG1: supplied by vcc3v3_sys_s3
[ 6.750927] SWITCH_REG2: supplied by vcc3v3_sys_s3
[ 6.755541] rk808-rtc rk808-rtc: rtc core: registered rk808-rtc as rtc0
[ 6.757574] fan53555-regulator 0-0040: FAN53555 Option[8] Rev[1] Detected!
[ 6.758288] fan53555-reg: supplied by vcc5v0_sys
[ 6.761492] fan53555-regulator 0-0041: FAN53555 Option[8] Rev[1] Detected!
[ 6.762192] fan53555-reg: supplied by vcc5v0_sys
[ 6.765075] rk3x-i2c ff3c0000.i2c: Initialized RK3xxx I2C bus at fffff8009a64000
[ 6.769002] rk3x-i2c ff120000.i2c: Initialized RK3xxx I2C bus at fffff8009a66000
[ 6.770641] rk3x-i2c ff160000.i2c: Initialized RK3xxx I2C bus at fffff8009a68000
[ 6.777155] fusb302 4-0022: port 0 probe success with role ROLE_MODE_DRP, try_role ROLE_MODE_UFP
[ 6.778349] input: Typec_Headphone as /devices/platform/ff3d0000.i2c/i2c-4/4-0022/input/input0
[ 6.779545] rk3x-i2c ff3d0000.i2c: Initialized RK3xxx I2C bus at fffff8009a6a000
[ 6.781274] rk3x-i2c ff3e0000.i2c: Initialized RK3xxx I2C bus at fffff8009a6c000
[ 6.785169] usbcore: registered new interface driver uvcvideo
[ 6.785703] USB Video Class driver (1.1.1)
[ 6.790057] Boot mode: normal
[ 6.793278] rk_tsadc_v2_temp_to_code: Invalid conversion table: code=1023, temperature=2147483647
[ 6.794332] rockchip-thermal ff260000.tsadc: tsadc is probed successfully!
[ 6.795718] dw_wdt ff848000.watchdog: Should better to setup a 'resets' property in dt, that must be named with reset
[ 6.797703] device-mapper: uevent: version 1.0.3
[ 6.798855] device-mapper: ioctl: 4.34.0-ioctl (2015-10-28) initialised: dm-devel@redhat.com
[ 6.800338] cpu cpu0: bin=0
[ 6.800667] cpu cpu0: leakage=20
[ 6.813444] cpu cpu0: temp=55555, pvtm=150030 (149106 + 924)
[ 6.814199] cpu cpu0: pvtm-volt-sel=2
[ 6.814613] cpu cpu0: bin-scale=30
[ 6.815287] cpu cpu4: bin=0
[ 6.815612] cpu cpu4: leakage=33
[ 6.828733] cpu cpu4: temp=55555, pvtm=155536 (155046 + 490)
[ 6.830360] cpu cpu4: pvtm-volt-sel=2
[ 6.830766] cpu cpu4: bin-scale=8
[ 6.833086] cpu cpu0: avs=0
[ 6.833480] cpu cpu0: l=0 h=2147483647 hyst=5000 l_limit=0 h_limit=0
[ 6.834903] cpu cpu0: failed to find power_model node
[ 6.837201] cpu cpu4: avs=0
[ 6.837588] cpu cpu4: l=0 h=2147483647 hyst=5000 l_limit=0 h_limit=0
[ 6.840588] cpu cpu4: failed to find power_model node
[ 6.842078] sdhci: Secure Digital Host Controller Interface driver
[ 6.842626] sdhci: Copyright(c) Pierre Ossman
[ 6.843015] Synopsys Designware Multimedia Card Interface Driver
[ 6.844231] dwmmc_rockchip fe320000.dwmmc: IDMAC supports 32-bit address mode.
[ 6.844922] dwmmc_rockchip fe320000.dwmmc: Using internal DMA controller.
[ 6.845536] dwmmc_rockchip fe320000.dwmmc: Version ID is 270a
[ 6.846090] dwmmc_rockchip fe320000.dwmmc: DW MMC controller at irq 25,32 bit host data width,256 deep fifo
[ 6.847371] rockchip-iodomain ff70000.syscon:io-domains: Setting to 3300000 done
[ 6.848432] rockchip-iodomain ff70000.syscon:io-domains: Setting to 3000000 done
[ 6.864393] mmc_host mmc0: Bus speed (slot 0) = 400000Hz (slot req 400000Hz, actual 400000HZ div = 0)
[ 6.881400] dwmmc_rockchip fe320000.dwmmc: 1 slots initialized
[ 6.884233] sdhci-pllfm: SDHCI platform and OF driver helper
[ 6.887324] sdhci-aranan fe330000.sdhci: No vqmmc regulator found
[ 6.887863] sdhci-aranan fe330000.sdhci: No vqmmc regulator found
[ 6.911145] fusb302 4-0022: CC connected in CC2 as UFP
[ 6.924401] mmc1: SDHCI controller on fe330000.sdhci [fe330000.sdhci] using ADMA

```



```

[ 6.935506] ledtrig-cpu: registered to indicate activity on CPUs
[ 6.936279] hidraw: raw HID events driver (C) Jiri Kosina
[ 6.937911] usbcore: registered new interface driver usbhid
[ 6.938431] usbhid: USB HID core driver
[ 6.939391] ashmem: initialized
[ 6.951794] rockchip-iodomain ff770000.syscon:io-domains: Setting to 3000000 done
[ 6.952674] rockchip-iodomain ff770000.syscon:io-domains: Setting to 1800000 done
[ 6.953115] Initializing XFRM netlink socket
[ 6.953878] NET: Registered protocol family 10
[ 6.955170] lib80211: common routines for IEEE802.11 drivers
[ 6.955712] [WLAN_RFKILL]: Enter rfkill_wlan_init
[ 6.956401] [BT_RFKILL]: Enter rfkill_rk_init
[ 6.956911] Key type dns_resolver registered
[ 6.957578] sensor_register_slave:mpu6880_gyro,id=50
[ 6.958095] Error: Driver 'ov7750' is already registered, aborting...
[ 6.958670] Error: Driver 'ov8858' is already registered, aborting...
[ 6.959316] Error: Driver 'sc031gs' is already registered, aborting...
[ 6.960266] Registered cp15_barrier emulation handler
[ 6.961177] Registered setend emulation handler
[ 6.962439] registered taskstats version 1
[ 6.962815] Loading compiled-in X.509 certificates
[ 6.963424] kmemleak: Kernel memory leak detector initialized
[ 6.963428] kmemleak: Automatic memory scanning thread started
[ 6.966904] Btrfs loaded, integrity-checker=on
[ 6.967411] BTRFS: selftest: Running btrfs free space cache tests
[ 6.968000] BTRFS: selftest: Running extent only tests
[ 6.968550] BTRFS: selftest: Running bitmap only tests
[ 6.969033] BTRFS: selftest: Running bitmap and extent tests
[ 6.969591] BTRFS: selftest: Running space stealing from bitmap to extent
[ 6.970518] BTRFS: selftest: Free space cache tests finished
[ 6.971019] BTRFS: selftest: Running extent buffer operation tests
[ 6.971549] BTRFS: selftest: Running btrfs_split_item tests
[ 6.972108] BTRFS: selftest: Running find_dalalloc tests
[ 6.974050] mmc_host mmc0: Bus speed (slot 0) = 150000000Hz (slot req 150000000Hz, actual 150000000Hz div = 0)
[ 7.006155] mmc1: new HS400 Enhanced strobe MMC card at address 0001
[ 7.008873] mmcblk1: mmc1:0001 AJTD4R 14.6 GiB
[ 7.010366] mmcblk1boot0: mmc1:0001 AJTD4R partition 1 4.00 MiB
[ 7.011850] mmcblk1boot1: mmc1:0001 AJTD4R partition 2 4.00 MiB
[ 7.013692] mmcblk1rmb: mmc1:0001 AJTD4R partition 3 4.00 MiB
[ 7.100458] BTRFS: selftest: Running btrfs_get_extent tests
[ 7.101192] BTRFS: selftest: Running hole first btrfs_get_extent test
[ 7.101805] BTRFS: selftest: Running outstanding_extents tests
[ 7.102420] BTRFS: selftest: Running qgroup tests
[ 7.102841] BTRFS: selftest: Qgroup basic add
[ 7.103323] BTRFS: selftest: Qgroup multiple refs test
[ 7.114784] dwmmc_rockchip fe320000.dwmcc: Successfully tuned phase to 228
[ 7.115426] mmc0: new ultra high speed SDR104 SDHC card at address aaaa
[ 7.117132] mmcblk0: mmc0:aaaa SC16G 14.8 GiB
[ 7.119791] mmcblk0: p1
[ 7.146709] random: nonblocking pool is initialized
[ 7.156189] Key type encrypted registered
[ 7.157563] rga2: Driver loaded successfully ver:3.02
[ 7.158194] rga2: Module initialized.
[ 7.161014] phy-ff770000.syscon:usb2-phy@e450.7: Failed to get VBUS supply regulator
[ 7.166820] rockchip-pcie f8000000.pcie: bus-scan-delay-ms in device tree is 2000 ms
[ 7.167562] rockchip-pcie f8000000.pcie: missing "memory-region" property
[ 7.168215] PCI host bridge /pcie@f8000000 ranges:
[ 7.168723] MEM 0xfa000000..0xfbffff -> 0xfa000000
[ 7.169219] IO 0xfb000000..0xfbffff -> 0xfb000000
[ 7.196338] rockchip-pcie f8000000.pcie: invalid power supply
[ 7.302671] rockchip-pcie f8000000.pcie: wait 2000 ms (from device tree) before bus scan
[ 7.466047] vendor storage:20190527 ret = 0
[ 9.304927] rockchip-pcie f8000000.pcie: PCI host bridge to bus 0000:00
[ 9.305563] pci_bus 0000:00: root bus resource [bus 00-1f]
[ 9.306089] pci_bus 0000:00: root bus resource [mem 0xfa000000-0xfbffff]
[ 9.306733] pci_bus 0000:00: root bus resource [io 0x0000-0xffff] (bus address [0xfb000000-0xfbffff])
[ 9.308818] pci 0000:00:00.0: bridge configuration invalid ([bus 00-00]), reconfiguring
[ 9.310151] pci 0000:01:00.0: reg 0x10: initial BAR value 0x00000000 invalid
[ 9.310849] pci 0000:01:00.0: reg 0x14: initial BAR value 0x00000000 invalid
[ 9.311544] pci 0000:01:00.0: reg 0x18: initial BAR value 0x00000000 invalid
[ 9.312240] pci 0000:01:00.0: reg 0x1c: initial BAR value 0x00000000 invalid
[ 9.312956] pci 0000:01:00.0: reg 0x20: initial BAR value 0x00000000 invalid
[ 9.320526] pci 0000:00:00.0: BAR 8: assigned [mem 0xfa000000-0xfa0ffff]
[ 9.321166] pci 0000:00:00.0: BAR 7: assigned [io 0x1000-0x1fff]
[ 9.321779] pci 0000:01:00.0: BAR 6: assigned [mem 0xfa000000-0xfa0ffff pref]
[ 9.322471] pci 0000:01:00.0: BAR 5: assigned [mem 0xfa010000-0xfa011fff]
[ 9.323118] pci 0000:01:00.0: BAR 0: assigned [io 0x1000-0x107f]
[ 9.323696] pci 0000:01:00.0: BAR 1: assigned [io 0x1080-0x10ff]
[ 9.324275] pci 0000:01:00.0: BAR 2: assigned [io 0x1100-0x117f]
[ 9.324936] pci 0000:01:00.0: BAR 3: assigned [io 0x1180-0x11ff]
[ 9.325517] pci 0000:01:00.0: BAR 4: assigned [io 0x1200-0x127f]
[ 9.326108] pci 0000:00:00.0: PCI bridge to [bus 01]
[ 9.326582] pci 0000:00:00.0: bridge window [io 0x1000-0x1fff]
[ 9.327152] pci 0000:00:00.0: bridge window [mem 0xfa000000-0xfa0ffff]
[ 9.327995] pcieport 0000:00:00.0: enabling device (0000 -> 0003)
[ 9.329351] pcieport 0000:00:00.0: Signaling PME through PCIe PME interrupt
[ 9.330001] pci 0000:01:00.0: Signaling PME through PCIe PME interrupt
[ 9.331306] ahci 0000:01:00.0: enabling device (0000 -> 0003)
[ 9.333226] ahci 0000:01:00.0: SSS flag set, parallel bus scan disabled
[ 9.333943] ahci 0000:01:00.0: AHCI 0001.0301 32 slots 5 ports 6 Gbps 0x1f impl SATA mode
[ 9.334719] ahci 0000:01:00.0: flags: 64bit ncq snff stag pm led clo pmp fbs pio slum part ccc apst boh
[ 9.343674] scsi host0: ahci
[ 9.345011] scsi host1: ahci
[ 9.346388] scsi host2: ahci
[ 9.347727] scsi host3: ahci
[ 9.349142] scsi host4: ahci
[ 9.350143] ata1: SATA max UDMA/133 abar m8192@0xfa010000 port 0xfa010100 irq 255
[ 9.350850] ata2: SATA max UDMA/133 abar m8192@0xfa010000 port 0xfa010180 irq 256
[ 9.351547] ata3: SATA max UDMA/133 abar m8192@0xfa010000 port 0xfa010200 irq 257

```

```

[ 9.352249] ata4: SATA max UDMA/133 abar m8192@0xfa010000 port 0xfa010280 irq 258
[ 9.352970] ata5: SATA max UDMA/133 abar m8192@0xfa010000 port 0xfa010300 irq 259
[ 9.359882] xhci-hcd xhci-hcd.2.auto: xHCI Host Controller
[ 9.361004] xhci-hcd xhci-hcd.2.auto: new USB bus registered, assigned bus number 1
[ 9.362049] xhci-hcd xhci-hcd.2.auto: hcc params 0x0220fe64 hci version 0x110 quirks 0x06030010
[ 9.362949] xhci-hcd xhci-hcd.2.auto: irq 223, io mem 0xfe800000
[ 9.364030] usb usb1: New USB device found, idVendor=1d6b, idProduct=0002
[ 9.364679] usb usb1: New USB device strings: Mfr=3, Product=2, SerialNumber=1
[ 9.365360] usb usb1: Product: xHCI Host Controller
[ 9.365814] usb usb1: Manufacturer: Linux 4.4.213-rk3399 xhci-hcd
[ 9.366388] usb usb1: SerialNumber: xhci-hcd.2.auto
[ 9.368215] hub 1-0:1.0: USB hub found
[ 9.368729] hub 1-0:1.0: 1 port detected
[ 9.369924] xhci-hcd xhci-hcd.2.auto: xHCI Host Controller
[ 9.370940] xhci-hcd xhci-hcd.2.auto: new USB bus registered, assigned bus number 2
[ 9.371784] usb usb2: We don't know the algorithms for LPM for this host, disabling LPM.
[ 9.372931] usb usb2: New USB device found, idVendor=1d6b, idProduct=0003
[ 9.373579] usb usb2: New USB device strings: Mfr=3, Product=2, SerialNumber=1
[ 9.374261] usb usb2: Product: xHCI Host Controller
[ 9.374731] usb usb2: Manufacturer: Linux 4.4.213-rk3399 xhci-hcd
[ 9.375295] usb usb2: SerialNumber: xhci-hcd.2.auto
[ 9.377659] hub 2-0:1.0: USB hub found
[ 9.378107] hub 2-0:1.0: 1 port detected
[ 9.383392] xhci-hcd xhci-hcd.2.auto: remove, state 1
[ 9.383949] usb usb2: USB disconnect, device number 1
[ 9.390022] xhci-hcd xhci-hcd.3.auto: xHCI Host Controller
[ 9.391219] xhci-hcd xhci-hcd.3.auto: new USB bus registered, assigned bus number 3
[ 9.392573] xhci-hcd xhci-hcd.3.auto: hcc params 0x0220fe64 hci version 0x110 quirks 0x06030010
[ 9.393501] xhci-hcd xhci-hcd.3.auto: irq 224, io mem 0xfe900000
[ 9.394658] usb usb3: New USB device found, idVendor=1d6b, idProduct=0002
[ 9.395301] usb usb3: New USB device strings: Mfr=3, Product=2, SerialNumber=1
[ 9.395983] usb usb3: Product: xHCI Host Controller
[ 9.396465] usb usb3: Manufacturer: Linux 4.4.213-rk3399 xhci-hcd
[ 9.397030] usb usb3: SerialNumber: xhci-hcd.3.auto
[ 9.399134] hub 3-0:1.0: USB hub found
[ 9.399570] hub 3-0:1.0: 1 port detected
[ 9.400954] xhci-hcd xhci-hcd.3.auto: xHCI Host Controller
[ 9.402017] xhci-hcd xhci-hcd.3.auto: new USB bus registered, assigned bus number 4
[ 9.402415] xhci-hcd xhci-hcd.2.auto: Host not halted after 16000 microseconds.
[ 9.402426] xhci-hcd xhci-hcd.2.auto: Host controller not halted, aborting reset.
[ 9.402475] xhci-hcd xhci-hcd.2.auto: USB bus 2 deregistered
[ 9.402941] xhci-hcd xhci-hcd.2.auto: remove, state 1
[ 9.402966] usb usb1: USB disconnect, device number 1
[ 9.404015] xhci-hcd xhci-hcd.2.auto: USB bus 1 deregistered
[ 9.406381] usb usb4: We don't know the algorithms for LPM for this host, disabling LPM.
[ 9.407442] usb usb4: New USB device found, idVendor=1d6b, idProduct=0003
[ 9.408085] usb usb4: New USB device strings: Mfr=3, Product=2, SerialNumber=1
[ 9.408799] usb usb4: Product: xHCI Host Controller
[ 9.409267] usb usb4: Manufacturer: Linux 4.4.213-rk3399 xhci-hcd
[ 9.409831] usb usb4: SerialNumber: xhci-hcd.3.auto
[ 9.411955] hub 4-0:1.0: USB hub found
[ 9.412567] hub 4-0:1.0: 1 port detected
[ 9.418601] ehci-platform fe380000.usb: EHCI Host Controller
[ 9.419651] ehci-platform fe380000.usb: new USB bus registered, assigned bus number 1
[ 9.420858] ehci-platform fe380000.usb: irq 27, io mem 0xfe380000
[ 9.432309] ehci-platform fe380000.usb: USB 2.0 started, EHCI 1.00
[ 9.433221] usb usb1: New USB device found, idVendor=1d6b, idProduct=0002
[ 9.433851] usb usb1: New USB device strings: Mfr=3, Product=2, SerialNumber=1
[ 9.434518] usb usb1: Product: EHCI Host Controller
[ 9.434972] usb usb1: Manufacturer: Linux 4.4.213-rk3399 ehci_hcd
[ 9.435525] usb usb1: SerialNumber: fe380000.usb
[ 9.437277] hub 1-0:1.0: USB hub found
[ 9.437687] hub 1-0:1.0: 1 port detected
[ 9.439563] ohci-platform fe3a0000.usb: Generic Platform OHCI controller
[ 9.440697] ohci-platform fe3a0000.usb: new USB bus registered, assigned bus number 2
[ 9.441643] ohci-platform fe3a0000.usb: irq 28, io mem 0xfe3a0000
[ 9.501071] usb usb2: New USB device found, idVendor=1d6b, idProduct=0001
[ 9.501741] usb usb2: New USB device strings: Mfr=3, Product=2, SerialNumber=1
[ 9.502462] usb usb2: Product: Generic Platform OHCI controller
[ 9.503051] usb usb2: Manufacturer: Linux 4.4.213-rk3399 ohci_hcd
[ 9.503641] usb usb2: SerialNumber: fe3a0000.usb
[ 9.506968] hub 2-0:1.0: USB hub found
[ 9.507454] hub 2-0:1.0: 1 port detected
[ 9.511367] input: adc-keys as /devices/platform/adc-keys/input/input1
[ 9.517213] input: gpio-keys as /devices/platform/gpio-keys/input/input2
[ 9.518328] dhd_module_init: in Dongle Host Driver, version 1.579.77.41.10 (r)
[ 9.519039] ===== dhd_wlan_init_plat_data =====
[ 9.519528] [WLAN_RFKILL]: rockchip_wifi_get_oob_irq: Enter
[ 9.520072] [WLAN_RFKILL]: rockchip_wifi_get_oob_irq: rkill-wlan driver has not Successful initialized
[ 9.520181] rk808-rtc rk808-rtc: setting system clock to 2013-01-18 11:05:18 UTC (1358507118)
[ 9.521795] dhd_wlan_init_gpio: unknown oob irqflags !
[ 9.522285] dhd_wlan_init_gpio: WL_HOST_WAKE=-1, oob_irq=-1, oob_irq_flags=0x410
[ 9.522998] dhd_wlan_init_gpio: WL_REG_ON=-1
[ 9.523411] dhd_wifi_platform_load: Enter
[ 9.523852] Power-up adapter 'DHD generic adapter'
[ 9.524486] wifi_platform_set_power = 1
[ 9.524865] ===== PULL WL_REG_ON(-1) HIGH! =====
[ 9.525353] [WLAN_RFKILL]: rockchip_wifi_power: 1
[ 9.525804] [WLAN_RFKILL]: rockchip_wifi_power: rkill-wlan driver has not Successful initialized
[ 9.577179] ALSA device list:
[ 9.577476] #0: Dummy 1
[ 9.577721] #1: Loopback 1
[ 9.712347] usb 3-1: new high-speed USB device number 2 using xhci-hcd
[ 9.797205] fusb302 4-0022: PD disabled
[ 9.828523] wifi_platform_bus_enumerate device present 1
[ 9.829052] ===== Card detection to detect SDIO card! =====
[ 9.829638] sdio: host isn't initialization successfully.
[ 9.842302] usb 3-1: New USB device found, idVendor=2109, idProduct=2815
[ 9.842969] usb 3-1: New USB device strings: Mfr=1, Product=2, SerialNumber=0

```

```

[ 9.843654] usb 3-1: Product: USB2.0 Hub
[ 9.844161] usb 3-1: Manufacturer: VIA Labs, Inc.
[ 9.855223] hub 3-1:1.0: USB hub found
[ 9.855852] hub 3-1:1.0: 4 ports detected
[ 9.904535] ata1: SATA link up 6.0 Gbps (SStatus 133 SControl 300)
[ 9.906020] ata1.00: ATA-9: WDC WDS120G2G0A-00JH30, UE510000, max UDMA/133
[ 9.906714] ata1.00: 234455040 sectors, multi 1: LBA48 NCQ (depth 31/32)
[ 9.912224] ata1.00: configured for UDMA/133
[ 9.913766] scsi 0:0:0:0: Direct-Access ATA WDC WDS120G2G0A-0000 PQ: 0 ANSI: 5
[ 9.917299] sd 0:0:0:0: [sda] 234455040 512-byte logical blocks: (120 GB/112 GiB)
[ 9.919082] sd 0:0:0:0: [sda] Write Protect is off
[ 9.919906] sd 0:0:0:0: [sda] Write cache: enabled, read cache: enabled, doesn't support DPO or FUA
[ 9.926697] sd 0:0:0:0: [sda] Attached SCSI disk
[ 9.952739] usb 4-1: new SuperSpeed USB device number 2 using xhci-hcd
[ 10.040490] phy phy-ff770000.syscon:usb2-phy@e450.7: charger = USB_FLOATING_CHARGER
[ 10.040790] usb 4-1: New USB device found, idVendor=2109, idProduct=0815
[ 10.040798] usb 4-1: New USB device strings: Mfr=1, Product=2, SerialNumber=0
[ 10.040805] usb 4-1: Product: USB3.0 Hub
[ 10.040811] usb 4-1: Manufacturer: VIA Labs, Inc.
[ 10.047220] hub 4-1:1.0: USB hub found
[ 10.047784] hub 4-1:1.0: 4 ports detected
[ 10.047812] rockchip-dwc3 usb0: USB peripheral connected
[ 10.408601] ata2: SATA link up 6.0 Gbps (SStatus 133 SControl 300)
[ 10.410474] ata2.00: ATA-9: WDC WDS120G2G0A-00JH30, UE510000, max UDMA/133
[ 10.411148] ata2.00: 234455040 sectors, multi 1: LBA48 NCQ (depth 31/32)
[ 10.416632] ata2.00: configured for UDMA/133
[ 10.418924] scsi 1:0:0:0: Direct-Access ATA WDC WDS120G2G0A-0000 PQ: 0 ANSI: 5
[ 10.422675] sd 1:0:0:0: [sdb] 234455040 512-byte logical blocks: (120 GB/112 GiB)
[ 10.424123] sd 1:0:0:0: [sdb] Write Protect is off
[ 10.424809] sd 1:0:0:0: [sdb] Write cache: enabled, read cache: enabled, doesn't support DPO or FUA
[ 10.429682] sd 1:0:0:0: [sdb] Attached SCSI disk
[ 10.672600] usb 4-1.1: new SuperSpeed USB device number 3 using xhci-hcd
[ 10.690175] usb 4-1.1: New USB device found, idVendor=0781, idProduct=5591
[ 10.690837] usb 4-1.1: New USB device strings: Mfr=1, Product=2, SerialNumber=3
[ 10.691551] usb 4-1.1: Product: Ultra USB 3.0
[ 10.691981] usb 4-1.1: Manufacturer: SanDisk
[ 10.692435] usb 4-1.1: SerialNumber: 4C530001260415115285
[ 10.768597] usb 4-1.2: new SuperSpeed USB device number 4 using xhci-hcd
[ 10.785899] usb 4-1.2: New USB device found, idVendor=0781, idProduct=5591
[ 10.786543] usb 4-1.2: New USB device strings: Mfr=1, Product=2, SerialNumber=3
[ 10.787242] usb 4-1.2: Product: Ultra USB 3.0
[ 10.787656] usb 4-1.2: Manufacturer: SanDisk
[ 10.788070] usb 4-1.2: SerialNumber: 4C530001200415115285
[ 10.864539] usb 4-1.3: new SuperSpeed USB device number 5 using xhci-hcd
[ 10.882160] usb 4-1.3: New USB device found, idVendor=0781, idProduct=5591
[ 10.882803] usb 4-1.3: New USB device strings: Mfr=1, Product=2, SerialNumber=3
[ 10.883502] usb 4-1.3: Product: Ultra USB 3.0
[ 10.883917] usb 4-1.3: Manufacturer: SanDisk
[ 10.884387] usb 4-1.3: SerialNumber:
010154d57f88411f5cb5d4a70b2e4c6e46c7badeb98384524a454706908d7481661e00000000000000000328b181000172900915581073528e395
[ 10.916595] ata3: SATA link up 6.0 Gbps (SStatus 133 SControl 300)
[ 10.918484] ata3.00: ATA-9: WDC WDS120G2G0A-00JH30, UE510000, max UDMA/133
[ 10.919158] ata3.00: 234455040 sectors, multi 1: LBA48 NCQ (depth 31/32)
[ 10.924805] ata3.00: configured for UDMA/133
[ 10.927362] scsi 2:0:0:0: Direct-Access ATA WDC WDS120G2G0A-0000 PQ: 0 ANSI: 5
[ 10.931293] sd 2:0:0:0: [sdc] 234455040 512-byte logical blocks: (120 GB/112 GiB)
[ 10.933033] sd 2:0:0:0: [sdc] Write Protect is off
[ 10.933747] sd 2:0:0:0: [sdc] Write cache: enabled, read cache: enabled, doesn't support DPO or FUA
[ 10.938348] sd 2:0:0:0: [sdc] Attached SCSI disk
[ 10.960553] usb 4-1.4: new SuperSpeed USB device number 6 using xhci-hcd
[ 10.978501] usb 4-1.4: New USB device found, idVendor=0bda, idProduct=8156
[ 10.979161] usb 4-1.4: New USB device strings: Mfr=1, Product=2, SerialNumber=6
[ 10.979875] usb 4-1.4: Product: USB 10/100/1G/2.5G LAN
[ 10.980460] usb 4-1.4: Manufacturer: Realtek
[ 10.980880] usb 4-1.4: SerialNumber: 000000001
[ 11.428582] ata4: SATA link up 6.0 Gbps (SStatus 133 SControl 300)
[ 11.430446] ata4.00: ATA-9: WDC WDS120G2G0A-00JH30, UE510000, max UDMA/133
[ 11.431120] ata4.00: 234455040 sectors, multi 1: LBA48 NCQ (depth 31/32)
[ 11.436681] ata4.00: configured for UDMA/133
[ 11.438997] scsi 3:0:0:0: Direct-Access ATA WDC WDS120G2G0A-0000 PQ: 0 ANSI: 5
[ 11.442827] sd 3:0:0:0: [sdd] 234455040 512-byte logical blocks: (120 GB/112 GiB)
[ 11.444566] sd 3:0:0:0: [sdd] Write Protect is off
[ 11.445308] sd 3:0:0:0: [sdd] Write cache: enabled, read cache: enabled, doesn't support DPO or FUA
[ 11.451197] sd 3:0:0:0: [sdd] Attached SCSI disk
[ 11.828336] failed to power up DHD generic adapter, 1 retry left
[ 11.845083] wifi_platform_set_power = 0
[ 11.845483] ===== PULL WL_REG_ON(-1) LOW! =====
[ 11.845977] [WLAN_RFKILL]: rockchip_wifi_power: 0
[ 11.846454] [WLAN_RFKILL]: rockchip_wifi_power: rkill-wlan driver has not Successful initialized
[ 11.847313] wifi_platform_bus_enumerate device present 0
[ 11.847837] ===== Card detection to remove SDIO card! =====
[ 11.848480] sdio: host isn't initialization successfully.
[ 11.849189] wifi_platform_set_power = 1
[ 11.849577] ===== PULL WL_REG_ON(-1) HIGH! =====
[ 11.850090] [WLAN_RFKILL]: rockchip_wifi_power: 1
[ 11.850557] [WLAN_RFKILL]: rockchip_wifi_power: rkill-wlan driver has not Successful initialized
[ 11.940611] ata5: SATA link up 6.0 Gbps (SStatus 133 SControl 300)
[ 11.952288] ata5.00: ATA-9: WDC WDS120G2G0A-00JH30, UE360000, max UDMA/133
[ 11.953003] ata5.00: 234455040 sectors, multi 1: LBA48 NCQ (depth 31/32)
[ 11.959863] ata5.00: configured for UDMA/133
[ 11.962152] scsi 4:0:0:0: Direct-Access ATA WDC WDS120G2G0A-0000 PQ: 0 ANSI: 5
[ 11.965692] sd 4:0:0:0: [sde] 234455040 512-byte logical blocks: (120 GB/112 GiB)
[ 11.966883] sd 4:0:0:0: [sde] Write Protect is off
[ 11.967423] sd 4:0:0:0: [sde] Write cache: enabled, read cache: enabled, doesn't support DPO or FUA
[ 11.970529] sd 4:0:0:0: [sde] Attached SCSI disk
[ 11.972518] Freeing unused kernel memory: 3712K
[ 12.152359] wifi_platform_bus_enumerate device present 1
[ 12.152890] ===== Card detection to detect SDIO card! =====
[ 12.153461] sdio: host isn't initialization successfully.

```

```

[ 12.666099] md: bind<sde>
[ 12.733993] usb-storage 4-1.1.1.0: USB Mass Storage device detected
[ 12.737657] scsi host5: usb-storage 4-1.1.1.0
[ 12.738846] usb-storage 4-1.2.1.0: USB Mass Storage device detected
[ 12.739793] scsi host6: usb-storage 4-1.2.1.0
[ 12.741015] usb-storage 4-1.3.1.0: USB Mass Storage device detected
[ 12.741924] scsi host7: usb-storage 4-1.3.1.0
[ 12.743134] usbcore: registered new interface driver usb-storage
[ 12.745273] usbcore: registered new interface driver uas
[ 12.783365] md: linear personality registered for level -1
[ 12.791038] md: multipath personality registered for level -4
[ 12.797544] md: raid0 personality registered for level 0
[ 12.804052] md: raid1 personality registered for level 1
[ 12.810465] async_tx: api initialized (async)
[ 12.816260] md: raid6 personality registered for level 6
[ 12.816861] md: raid5 personality registered for level 5
[ 12.817343] md: raid4 personality registered for level 4
[ 12.836564] md: raid10 personality registered for level 10
[ 13.738421] scsi 5:0:0:0: Direct-Access SanDisk Ultra USB 3.0 1.00 PQ: 0 ANSI: 6
[ 13.742652] scsi 6:0:0:0: Direct-Access SanDisk Ultra USB 3.0 1.00 PQ: 0 ANSI: 6
[ 13.743479] sd 5:0:0:0: [sdf] 60063744 512-byte logical blocks: (30.8 GB/28.6 GiB)
[ 13.744933] sd 5:0:0:0: [sdf] Write Protect is off
[ 13.746168] sd 5:0:0:0: [sdf] Write cache: disabled, read cache: enabled, doesn't support DPO or FUA
[ 13.746647] scsi 7:0:0:0: Direct-Access SanDisk Ultra USB 3.0 1.00 PQ: 0 ANSI: 6
[ 13.753745] sd 7:0:0:0: [sdg] 60088320 512-byte logical blocks: (30.8 GB/28.7 GiB)
[ 13.755139] sd 7:0:0:0: [sdg] Write Protect is off
[ 13.756264] sd 7:0:0:0: [sdg] Write cache: disabled, read cache: enabled, doesn't support DPO or FUA
[ 13.758193] sd 6:0:0:0: [sdh] 60063744 512-byte logical blocks: (30.8 GB/28.6 GiB)
[ 13.760415] sd 6:0:0:0: [sdh] Write Protect is off
[ 13.761636] sd 6:0:0:0: [sdh] Write cache: disabled, read cache: enabled, doesn't support DPO or FUA
[ 13.771098] sd 5:0:0:0: [sdf] Attached SCSI removable disk
[ 13.774965] sd 6:0:0:0: [sdh] Attached SCSI removable disk
[ 13.778243] sd 7:0:0:0: [sdg] Attached SCSI removable disk
[ 14.152328] failed to power up DHD generic adapter, 0 retry left
[ 14.169096] wifi_platform_set_power = 0
[ 14.169500] ===== PULL WL_REG_ON(-1) LOW! =====
[ 14.170000] [WLAN_RFKILL]: rockchip_wifi_power: 0
[ 14.170448] [WLAN_RFKILL]: rockchip_wifi_power: rkill-wlan driver has not Successful initialized
[ 14.171282] wifi_platform_bus_enumerate device present 0
[ 14.171779] ===== Card detection to remove SDIO card! =====
[ 14.172390] sdio: host isn't initialization successfully.
[ 14.172910] failed to power up DHD generic adapter, max retry reached**
[ 14.173604] unregister wifi platform drivers
[ 14.174018] wifi_platform_bus_enumerate device present 0
[ 14.174514] ===== Card detection to remove SDIO card! =====
[ 14.175078] sdio: host isn't initialization successfully.
[ 14.175593] ===== dhd_wlan_deinit_plat_data =====
[ 14.176094] dhd_module_init: Failed to load the driver, try cnt 0
[ 14.176751] dhd_module_init: Failed to load driver max retry reached**
[ 14.177352] dhd_module_init: Exit err=-19
[ 19.029092] EXT4-fs (mmcblk0p1): mounted filesystem with writeback data mode. Opts: (null)
[ 19.449876] systemd[1]: System time before build time, advancing clock.
[ 19.468723] ip_tables: (C) 2000-2006 Netfilter Core Team
[ 19.476165] cgroup: cgroup2: unknown option "nsdelegate"
[ 19.495624] systemd[1]: systemd 237 running in system mode. (+PAM +AUDIT +SELINUX +IMA +APPARMOR +SMACK +SYSVINIT +UTMP +LIBCRYPTSETUP
+GCRYPT +GNUTLS +ACL +XZ +LZ4 +SECCOMP +BLKID +ELFUTILS +KMOD -IDN2 +IDN -PCRE2 default-hierarchy=hybrid)
[ 19.498745] systemd[1]: Detected architecture arm64.
[ 19.511178] systemd[1]: Set hostname to <helios64>.
[ 19.730507] systemd[1]: File /lib/systemd/system/systemd-journald.service:36 configures an IP firewall (IPAddressDeny=any), but the local system does not support
BPF/cgroup based firewalling.
[ 19.732084] systemd[1]: Proceeding WITHOUT firewalling in effect! (This warning is only shown for the first loaded unit using IP firewalling.)
[ 19.953235] systemd[1]: Reached target System Time Synchronized.
[ 19.954949] systemd[1]: Started Forward Password Requests to Wall Directory Watch.
[ 19.956253] systemd[1]: Started Dispatch Password Requests to Console Directory Watch.
[ 19.957342] systemd[1]: Reached target Local Encrypted Volumes.
[ 19.959564] systemd[1]: Created slice User and Session Slice.
[ 19.960535] systemd[1]: Reached target Remote File Systems.
[ 19.962673] systemd[1]: Created slice System Slice.
[ 19.964265] systemd[1]: Listening on Journal Socket.
[ 19.970888] systemd[1]: Starting Set the console keyboard layout...
[ 19.973252] systemd[1]: Listening on LVM2 metadata daemon socket.
[ 19.974811] systemd[1]: Listening on Journal Socket (/dev/log).
[ 19.975957] systemd[1]: Listening on Device-mapper event daemon FIFOs.
[ 19.982949] systemd[1]: Mounting Huge Pages File System...
[ 19.985319] systemd[1]: Listening on fsck to fsckd communication Socket.
[ 19.993085] systemd[1]: Starting Remount Root and Kernel File Systems...
[ 19.995100] systemd[1]: Listening on Syslog Socket.
[ 19.996422] systemd[1]: Listening on LVM2 poll daemon socket.
[ 19.997747] systemd[1]: Listening on udev Control Socket.
[ 20.005946] systemd[1]: Starting Nameserver information manager...
[ 20.008021] systemd[1]: Listening on Journal Audit Socket.
[ 20.015922] systemd[1]: Starting Availability of block devices...
[ 20.017551] systemd[1]: Listening on udev Kernel Socket.
[ 20.024728] systemd[1]: Starting udev Coldplug all Devices...
[ 20.033032] systemd[1]: Starting Monitoring of LVM2 mirrors, snapshots etc. using dmeventd or progress polling...
[ 20.043328] EXT4-fs (mmcblk0p1): re-mounted. Opts: commit=600,errors=remount-ro
[ 20.051371] systemd[1]: Starting Load Kernel Modules...
[ 20.052937] systemd[1]: Reached target Swap.
[ 20.055725] systemd[1]: Created slice system-serialx2dgetty.slice.
[ 20.058649] systemd[1]: Set up automount Arbitrary Executable File Formats File System Automount Point.
[ 20.078130] systemd[1]: Starting Create list of required static device nodes for the current kernel...
[ 20.088090] systemd[1]: Mounting Kernel Debug File System...
[ 20.097394] systemd[1]: Mounting POSIX Message Queue File System...
[ 20.098484] systemd[1]: Reached target Slices.
[ 20.099876] systemd[1]: Listening on /dev/initctl Compatibility Named Pipe.
[ 20.104919] systemd[1]: Mounted Huge Pages File System.
[ 20.108002] systemd[1]: Started Remount Root and Kernel File Systems.
[ 20.117222] systemd[1]: Started Availability of block devices.
[ 20.119860] systemd[1]: Started Load Kernel Modules.

```

```
[ 20.122660] systemd[1]: Started Create list of required static device nodes for the current kernel.
[ 20.124677] systemd[1]: Mounted Kernel Debug File System.
[ 20.125990] systemd[1]: Mounted POSIX Message Queue File System.
[ 20.134415] systemd[1]: Starting Create Static Device Nodes in /dev...
[ 20.143600] systemd[1]: Mounting Kernel Configuration File System...
[ 20.156067] systemd[1]: Starting Apply Kernel Variables...
[ 20.162602] systemd[1]: Mounting FUSE Control File System...
[ 20.169026] systemd[1]: Starting Load/Save Random Seed...
[ 20.182195] systemd[1]: Started Nameserver information manager.
[ 20.186749] systemd[1]: Mounted Kernel Configuration File System.
[ 20.188156] systemd[1]: Mounted FUSE Control File System.
```

Armbian 20.05.0-trunk Bionic ttyFIQ0

helios64 login: