



EMC Test Report

Report Number: UCSFC-2007-0057

Applicant

Kobol Innovations Pte. Ltd.
101 Cecil Street #26-01/07 Tong Eng Building Singapore 069533

Manufacturer

Kobol Innovations Pte. Ltd.
101 Cecil Street #26-01/07 Tong Eng Building Singapore 069533

Test information

Test product: **Single Board Computer**

Test model name: **Helios64**

Received number: **UCS-R-2020-1375**

Test date: **2020.07.14 ~ 2020.07.14**

Issued Date: **2020.07.22**

Test standards

FCC CFR 47 PART 15 SUBPART B, Section 15.101

The results shown in this test report refer only to the sample(s) tested unless otherwise stated.
This Test Report cannot be reproduced, except in full.

JWIM

Tested by: J. W. Im

I.Y. Jeong

Approved by: I.Y. Jeong

Product information

SoC	
SoC Model	Rockchip RK3399 - Hexacore 2x Cortex-A72 + 4x Cortex-A53
SoC Architecture	ARMv8-A 64-bit
CPU Frequency	A72 : 1.8 GHz A53 : 1.4 GHz
Additional Features	- GPU Mali-T860MP4 - Video Encoder/Decoder Engines - Security Acceleration Engines - Secure Boot
Memory	
LPDDR4 RAM	4GB
eMMC 5.1 NAND Flash	16GB
SPI NOR Flash	128Mb
HDD/SSD Interfaces	
SATA 3.0 Ports	5
M.2 SATA 3.0 Slot	1 (shared with SATA port 1)
Max Raw Capacity	80 TB (16 TB drive x 5)
External Interfaces	
Multi-Gigabit LAN Port (2.5Gbe)	1
Gigabit LAN Port (1Gbe)	1
USB Type-C	1
USB 3.0	3
microSD (SDIO 3.0)	1
Developer Interfaces	
GPIO	16
I2C	1
UEXT	1
Others	
PWM FAN	2
On-Board HDD Power	yes
Built-in UPS	yes
RTC Battery	yes
DC input	Dual 12V inputs
Wake-on-LAN	yes
Front Panel Extension	yes

Specifications: Refer to the manual

Contents

1. Testing laboratory	5
1.1 Location.....	5
2. Test Configuration and Condition	6
2.1 EUT operating condition	6
2.2 EUT test configuration diagram	6
2.3 Peripheral equipments list for test	6
2.4 Cable connections	7
2.5 EUT modifications	7
3. Summary of Test Results and Measurement Procedures.....	8
3.1 Summary of test results	8
3.2 Preliminary testing	8
3.3 Shielded enclosure.....	8
3.4 Data reporting format	8
3.5 AC powerlineconductedemissionstest.....	8
3.6 Radiated emission test	8
4. Test Results	9
4.1 Conducted Emission.....	9
4.2 Radiated emission	13
5. Appendix-A: Test Setup Photographs.....	20
5.1 Test Setup Photographs	20
5.1.1 Conducted emission	20
5.1.2 Radiated emission (below 1 GHz).....	21
5.1.3 Radiated emission (above 1 GHz).....	22
5.2. Appendix-C: Internal Photographs of EUT	23
6. Appendix-D: Label and Manual information	25



Revision History

Issued Report No.	Issued Date	Revisions	Effect Section
UCSFC-2007-0057	22-July-2020	Initial Issue	All

This report shall not be reproduced except in full, without the written approval of UCS Co., Ltd.

This document may be altered or revised by UCS Co., Ltd. personnel only, and shall be noted in the revision section of the document.

Any alteration of this document not carried out by UCS Co., Ltd. will constitute fraud and shall nullify the document.

1. Testing laboratory

1.1 Location

UCS Co., Ltd.

Office: #702, 268, Hagui-ro, Dongan-gu, Anyang-si, Gyeonggi-do, 14056, KOREA.

Tel: +82-1833-5681

Fax: +82-31-420-5685

EMC Center: 161-8, Ansdong-gil, Hwaseong-si, Gyeonggi-do, Korea

EMC Test Site: 35-13, Hwalcho-gil, 109beon-gil, Hwaseong-si, Gyeonggi-do, 18278, Korea

Tel: +82-1833-5681

Fax: +82-31-355-5848

Laboratory Accreditations and Listings

Country	Agency	Scope of Accreditation	Registration Number	Logo
USA	FCC	FCC Part 15 & 18 EMI (Electromagnetic Interference / Emission)	803225	

2. Test Configuration and Condition

2.1 EUT operating condition

- After connecting EUT and peripherals, the EUT was observed under controlled conditions using the PuTTY program continuously during the test
- Input power condition during the measurements was 120 V~, 60 Hz

2.2 EUT test configuration diagram

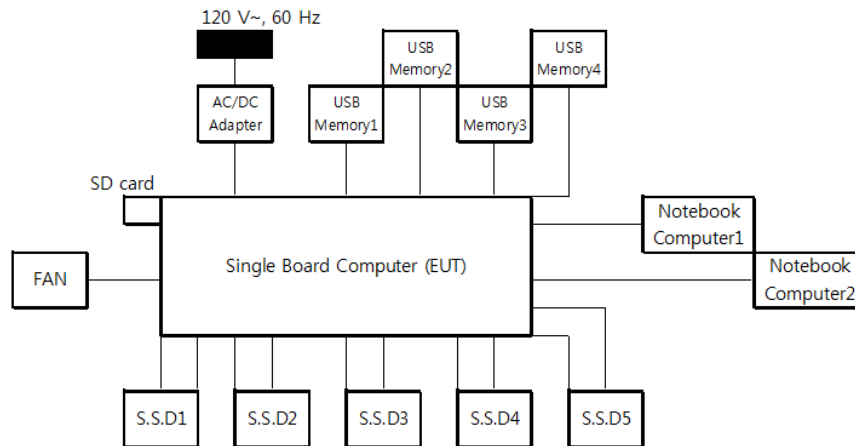

2.3 Peripheral equipments list for test

Equipment Name	Model	Serial Number	Manufacturer
Single Board Computer	Helios64	-	Kobol Innovations Pte. Ltd.
AC/DC Adapter	Yczx1210000T	-	-
S.S.D 1	WDS120G2G0A-00JH30	-	Western Digital Corporation
S.S.D 2	WDS120G2G0A-00JH30	-	Western Digital Corporation
S.S.D 3	WDS120G2G0A-00JH30	-	Western Digital Corporation
S.S.D 4	WDS120G2G0A-00JH30	-	Western Digital Corporation
S.S.D 5	WDS120G2G0A-00JH30	-	Western Digital Corporation
Notebook Computer1	NT501	-	SAMSUNG
Notebook Computer2	X40-D	-	Dynabook Technology (Hangzhou) Inc.
SD card	-	-	San Disk
FAN	-	-	-



USB Memory1	SDCZ73-032G	-	San Disk
USB Memory2	SDCZ73-032G	-	San Disk
USB Memory3	SDCZ73-032G	-	San Disk
USB Memory4	SDCZ73-032G	-	San Disk

2.4 Cable connections

Start		End		Cable	
Name	I/O Port	Name	I/O Port	Length (m)	Spec.
Single Board Computer (EUT)	DC in	AC/DC Adapter	DC out	1.0	Shield / Core
	DC out	S.S.D 1,2,3,4,5	DC in	0.5	Unshield
	SATA1,2,3,4,5	-	SATA1,2,3,4,5	0.5	Shield
	USB	USB Memory1,2,3	-	0.6	Shield
	USB C Type	USB Memory4	-	0.7	Shield
	FAN POWER	FAN	-	0.2	Unshield
	SD slot	SD card	-	-	-
	LAN1	Notebook Computer1	LAN	3.0	Shield
	LAN2	Notebook Computer2	USB	3.2	Shield

2.5 EUT modifications

- None

3. Summary of Test Results and Measurement Procedures

3.1 Summary of test results

Standard	Test Item	Results
FCC Part 15 Subpart A	Conducted Emission	Met Class A / Pass
FCC Part 15 Subpart A	Radiated Emission	Met Class A / Pass

3.2 Preliminary testing

It is often valuable to performing preliminary radiated measurements at a closer distance than specified for compliance to determine the emission characteristics of the EUT. At close-in distance, it is easier to determine the spectrum signature of EUT, and if applicable, the EUT configuration that emanate the maximum level of emissions. The data may not be precisely correlatable results.

3.3 Shielded enclosure

To search the Radiated frequency outline of an EUT a shielded screen room may be used. If the shielded room is used for radiated data, the data page will state that the EUT was in a shielded enclosure. All data collected in a screen room for emission data, radiated emissions is for frequency outline only. If an EUT is placed in screen room for AC Powerline Conducted the data page will show that a screen room was used and data frequencies and levels will be correct and used for test data.

3.4 Data reporting format

The measurement results expressed in accordance with C63.4 and specified limits where applicable are presented in tabular or graphical form, or alternatively as recorder charts or photographs of a spectrum analyzer display, showing the level vs. frequency.

3.5 AC powerline conducted emission test

The EUT was connected to LISN. All supporting equipments were connected to another LISN. Preliminary Power line Conducted Emission test was performed by using the procedure in ANSI C63.4:2014 7.3.3 to determine the worse operating conditions.

3.6 Radiated emission test

Preliminary radiated emission test was conducted using the procedure in ANSI C63.4:2014 8.3.1.1 to determine the worse operating conditions. Final radiated emission test was conducted at open area test site.

4. Test Results

4.1 Conducted Emission

Test Standard	FCC CFR 47 PART 15 SUBPART A, SECTION 15.107 (b)		
Test venue	Shield Room 2		
Tested Date	2020.07.14		
Input Ratings	120 V~, 60 Hz		
Tempature	20.0 °C	Humidity	41.0 % R.H.
Test result	Met Class A / Pass		

4.1.1 Limit

Frequency [MHz]	Class B [dB μ V]		Class A [dB μ V]	
	Quasi-Peak	Quasi-Peak	Quasi-Peak	Average
0.15 ~ 0.5	66 ~ 56*	56 ~ 46*	79	66
0.5 ~ 5	56	46	73	60
5 ~ 30	60	50	73	60

*Decreases with the logarithm of the frequency.

4.1.2 Test set-up and procedure

The mains terminal disturbance voltage was measured with the equipment under test (EUT) in a shield room.

The EUT was connected to an artificial mains network (LISN) placed on the floor.

The EUT was placed on non-metallic table 0.1 m above the metallic, grounded floor.

Amplitude measurements were performed with a quasi-peak detector and an average detector.

4.1.3 Test equipment used

Equipment	Model	Serial No.	Vendor	Next Cal. Date	Use
Test Receiver	ESPI3	101171	ROHDE & SCHWARZ	2020.08.01	<input type="checkbox"/>
Test Receiver	ESR7	101120	ROHDE & SCHWARZ	2020.08.01	<input checked="" type="checkbox"/>
LISN	NSLK 8127	8127518	SCHWARZBECK	2020.08.01	<input type="checkbox"/>
Two-Line V-Network	ENV216	3560.6550.12-101874-Rq	ROHDE & SCHWARZ	2020.08.01	<input type="checkbox"/>
Two-Line V-Network	ENV216	3560.6550.12-102073-Ax	ROHDE & SCHWARZ	2020.08.01	<input checked="" type="checkbox"/>
Four-Line V-Network	ENV432	101284	ROHDE & SCHWARZ	2020.08.01	<input type="checkbox"/>
EMI Receiver	9010	274WX90601	PMM	2020.08.01	<input type="checkbox"/>
ISN	ISN T800	30813	TESEQ	2021.01.31	<input type="checkbox"/>
ISN	ISN T8-Cat6	29709	TESEQ	2021.01.31	<input type="checkbox"/>
ARTIFICIAL MAINS NETWORK	L3-32	1220X20311	PMM	-	<input type="checkbox"/>

4.1.4 Test data

- Frequency range : 150 kHz ~ 30 MHz
- Bandwidth : 9 kHz

[Quasi-Peak]

Frequency [MHz]	LISN [dB]	Cable Loss [dB]	Line [H/N]	Limit [dB μ V]	Reading [dB μ V]	Results [dB μ V]	Margin [dB]
0.152	9.74	0.01	H	79.00	50.19	59.94	-19.06
0.168	9.96	0.01	H	79.00	49.51	59.48	-19.52
2.141	9.64	0.12	N	73.00	28.21	37.97	-35.03
16.004	9.70	0.25	H	73.00	32.66	42.61	-30.39

[Average]

Frequency [MHz]	LISN [dB]	Cable Loss [dB]	Line [H/N]	Limit [dB μ V]	Reading [dB μ V]	Results [dB μ V]	Margin [dB]
Average mode was not recorded, because Quasi-Peak values were under the Average limit.							

* Remark: "H" Hot Line, "N" Neutral Line

* **Results [dB μ V]** = Reading [dB μ V] + LISN [dB] + Cable Loss [dB]

* **Margin [dB]** = Results [dB μ V] - Limit [dB μ V]



4.1.5 Test graph

[Hot Line]

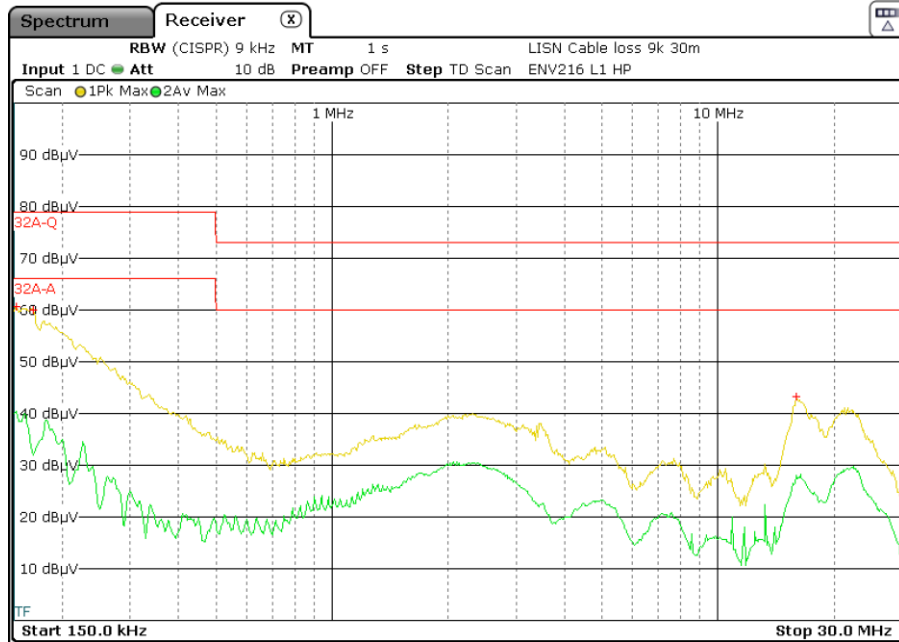

* — : Quasi-Peak, — : Average

[Neutral Line]

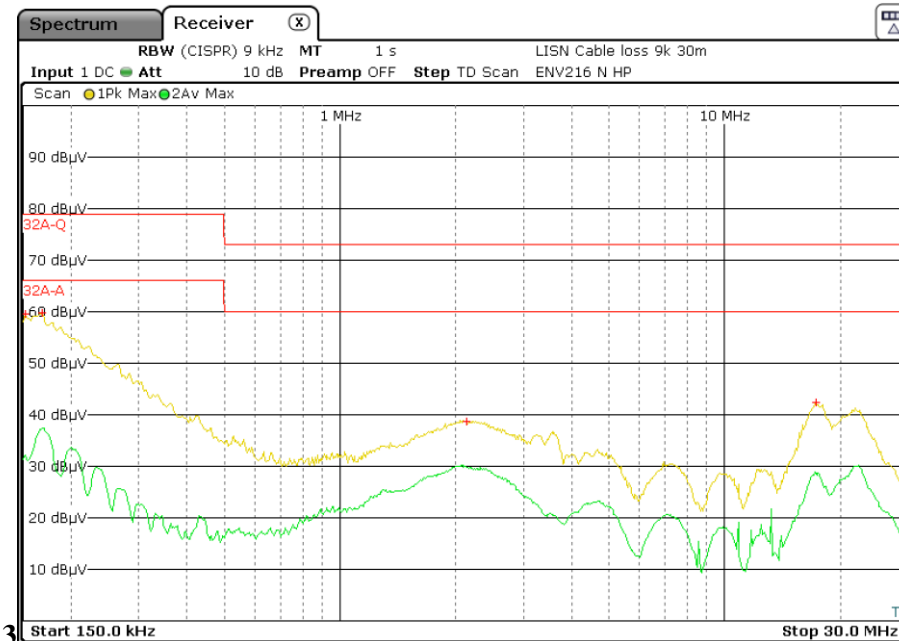

* — : Quasi-Peak, — : Average

4.2 Radiated emission

Test Standard	FCC CFR 47 PART 15 SUBPART A, SECTION 15.109 (b)		
Test venue	10 m chamber		
Tested Date	2020.07.14		
Input Ratings	120 V~, 60 Hz		
Temperature	20.8 °C	Humidity	41.0 % R.H.
Test result	Met Class A / Pass		

4.2.1 Limit

Frequency [MHz]	Class B @ 3 m	Class A @ 10 m
30 ~ 88	100 μ V/m (40.00 dB μ V/m)	90 μ V/m (39.08 dB μ V/m)
88 ~ 216	150 μ V/m (43.52 dB μ V/m)	150 μ V/m (43.52 dB μ V/m)
216 ~960	200 μ V/m (46.02 dB μ V/m)	210 μ V/m (46.44 dB μ V/m)
Above 960	500 μ V/m (53.98 dB μ V/m)	300 μ V/m (49.54 dB μ V/m)

4.2.2 Test set-up and procedure

The final test was done at a 10 m semi-anechoic chamber with a quasi-peak detector. EUT was placed on a non-metallic table height of 0.1 m above the reference ground plane. Cables connected to EUT were fixed to cause maximum emission. Test was made with the antenna positioned in both the horizontal and vertical planes of polarization. The measurement antenna was varied in height above the conducting ground plane to obtain the maximum signal strength.

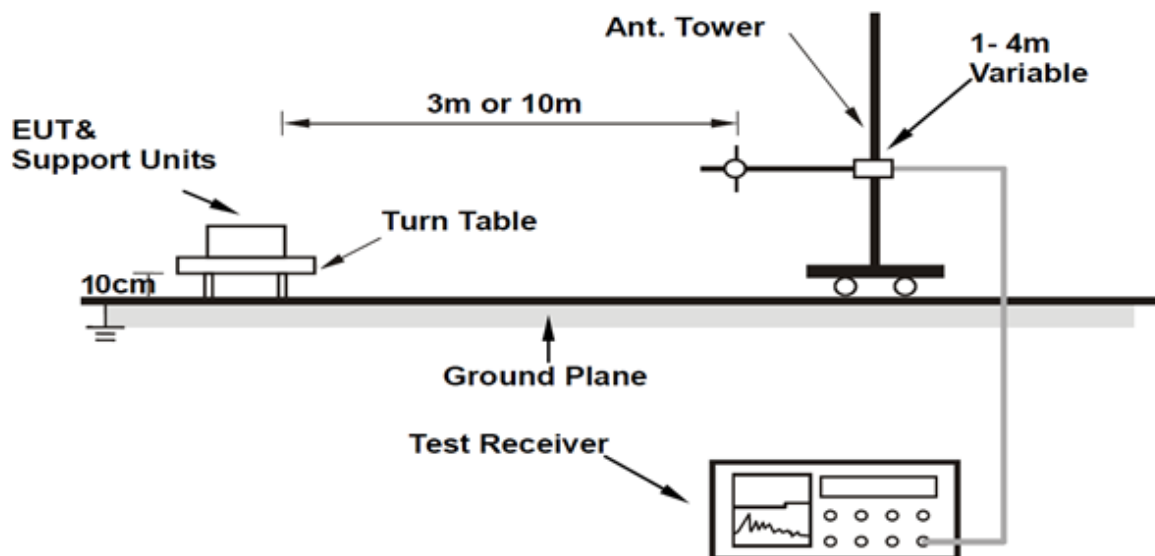

Note: Cable on the RGP must to be insulated.

4.2.3 Test equipment used

Equipment	Model	Serial No.	Vendor	Next Cal. Date	Use
Test Receiver	ESR7	101969	ROHDE & SCHWARZ	2020.08.03	■
Test Receiver	ESR7	101120	ROHDE & SCHWARZ	2020.08.01	□
BI-LOG ANT	VULB 9163	700	SCHWARZBECK	2021.07.12	■
Antenna Mast	MA4000-EP	-	Innco systems GmbH	-	■
Turntable	DT3000-t2	-	Innco systems GmbH	-	■
Controller	CO3000	CO3000/969/394 21016/L	Innco systems GmbH	-	■
HORN ANTENNA	BBHA 9120D	768	Schwarzbeck	2020.11.06	■
Antenna Master	MA4640/800-XP- ET	-	Innco systems GmbH	-	■
Antenna Master	act-a400	20090812002	AudixCoperation	-	□
Turn Table	act-t450	2009814072	AudixCoperation	-	□
AMPLIFIER	310N	291723	SONOMA	2020.08.01	□
Controller	act	CT-0131	AudixCoperation	-	□
Microwave Preamplifier	8449B	3008A02014	Agilent	2021.01.31	■
RF AMPLIFIER	8447F	2944A04074	H.P	2021.01.30	■

4.2.4 Test data (below 1 GHz)

- Frequency range : 30 MHz ~ 1 000 MHz
- Bandwidth : 120 kHz
- Distance : 10 m

Frequency [MHz]	Reading [dB μ V]	Antenna Polarity [H/V]	Height [m]	Antenna Factor [dB/m]	Cable Loss [dB]	Amp. Gain [dB]	Results [dB μ V/m]	Limit [dB μ V/m]	Margin [dB]
41.53	35.16	V	1.00	19.27	1.44	26.68	29.19	39.08	-9.89
60.80	34.81	V	1.00	18.39	1.70	26.66	28.24	39.08	-10.84
213.33	40.37	V	1.00	17.03	3.04	26.06	34.38	43.52	-9.14
375.00	38.49	H	4.00	20.87	4.10	26.47	36.99	46.44	-9.45

* Radiated emissions tabulated data

* Remark: "H" Horizontal, "V" Vertical

* Field strength calculation

Results [dB μ V/m] = Reading [dB μ V] + Antenna Factor [dB/m] + Cable Loss [dB] – Amp. Gain [dB]

Margin [dB] = Results [dB μ V/m] – Limit [dB μ V/m]

Measurement uncertainty

Radiated emission electric field intensity, 30 MHz ~ 1 000 MHz: 3.3 dB

Radiated emission electric field intensity, above 1 GHz: 4.8 dB

4.2.6 Test graph (below 1 GHz)

[Horizontal]

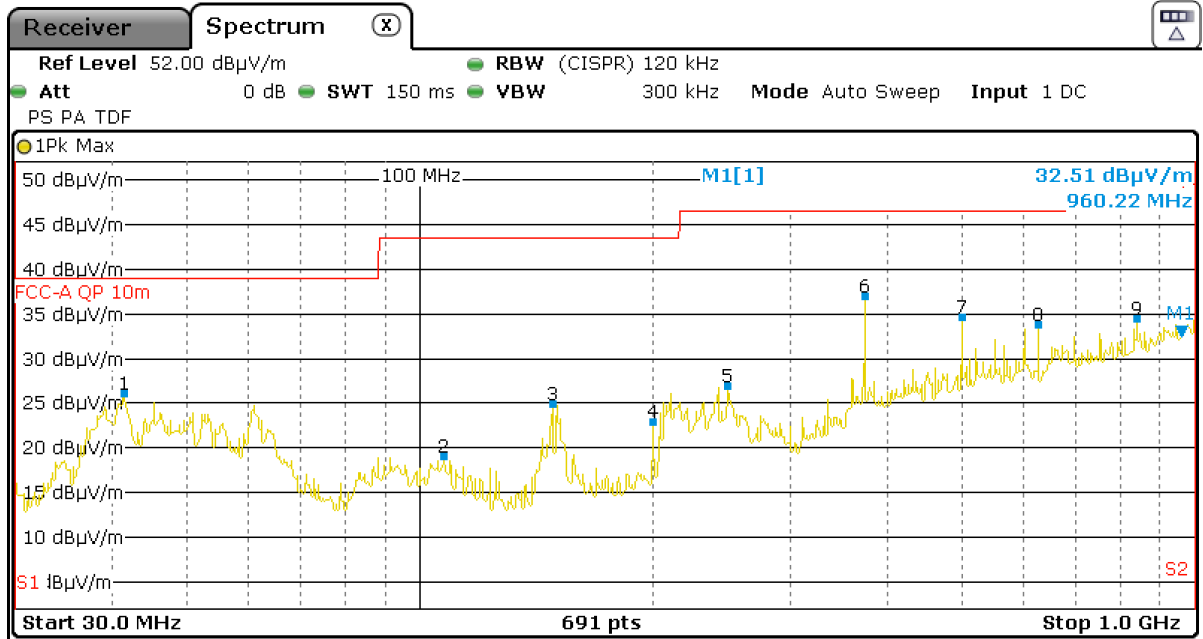

[Vertical]

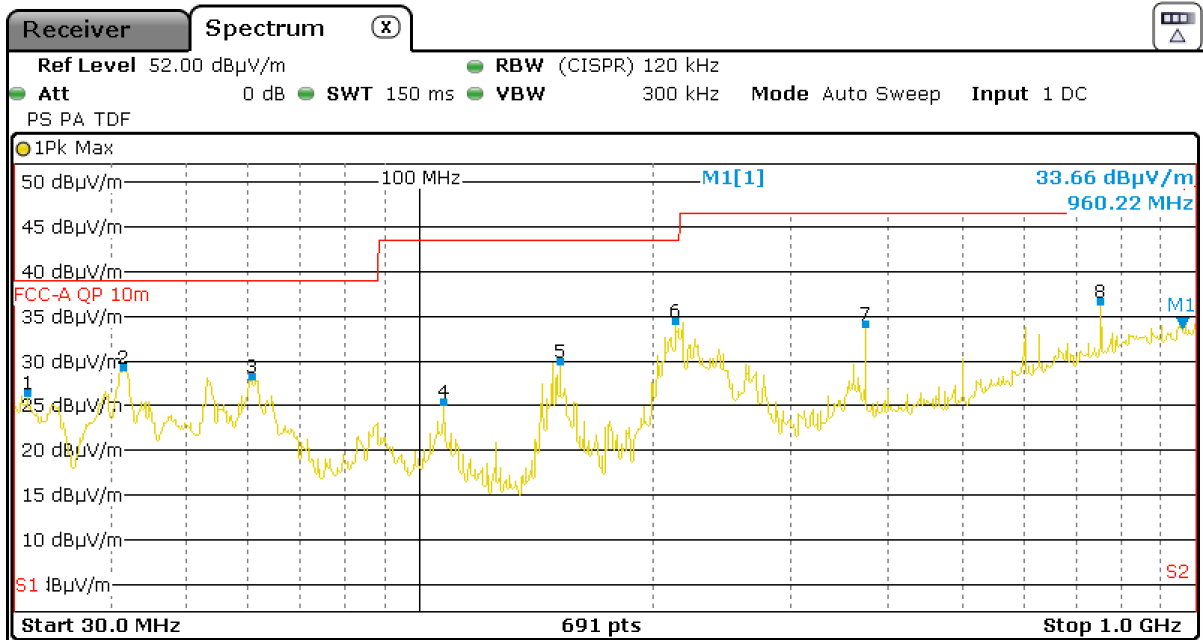

4.2.7 Test data(above 1 GHz)

- Frequency range : 1 000 MHz ~ 9 000 MHz
- Bandwidth : 1 MHz
- Distance : 3 m

[Horizontal]

[Peak]

Frequency [MHz]	Reading [dB μ V]	Height [m]	Antenna Factor [dB/m]	Cable Loss [dB]	Amp. Gain [dB]	Results [dB μ V/m]	Limit [dB μ V/m]	Margin [dB]
1 004	50.94	1.00	23.82	5.10	37.62	42.24	76.00	-33.76
1 402	50.11	1.00	24.72	6.18	36.98	44.03	76.00	-31.97

* Results [dB μ V/m] = Reading [dB μ V] + Antenna Factor [dB/m] + Cable Loss [dB] – Amp. Gain [dB]

* Margin [dB] = Results [dB μ V/m] – Limit [dB μ V/m]

[Average]

Frequency [MHz]	Reading [dB μ V]	Height [m]	Antenna Factor [dB/m]	Cable Loss [dB]	Amp. Gain [dB]	Results [dB μ V/m]	Limit [dB μ V/m]	Margin [dB]
1 004	37.71	1.00	23.82	5.10	37.62	29.01	56.00	-26.99
1 402	35.66	1.00	24.72	6.18	36.98	29.58	56.00	-26.42

* Results [dB μ V/m] = Reading [dB μ V] + Antenna Factor [dB/m] + Cable Loss [dB] – Amp. Gain [dB]

* Margin [dB] = Results [dB μ V/m] – Limit [dB μ V/m]

[Vertical]

[Peak]

Frequency [MHz]	Reading [dBμV]	Height [m]	Antenna Factor [dB/m]	Cable Loss [dB]	Amp. Gain [dB]	Results [dBμV/m]	Limit [dBμV/m]	Margin [dB]
1 004	49.63	1.00	23.82	5.10	37.62	40.93	76.00	-35.07
1 800	47.50	1.00	25.61	7.21	36.49	43.83	76.00	-32.17
2 002	47.08	1.00	26.05	7.72	36.27	44.58	76.00	-31.42
2 342	47.27	1.00	27.04	8.47	36.25	46.53	76.00	-29.47

* Results [dBμV/m] = Reading [dBμV] + Antenna Factor [dB/m] + Cable Loss [dB] – Amp. Gain [dB]

* Margin [dB] = Results [dBμV/m] – Limit [dBμV/m]

[Average]

Freq. [MHz]	Reading [dBμV]	Height [m]	Antenna Factor [dB/m]	Cable Loss [dB]	Amp. Gain [dB]	Results [dBμV/m]	Limit [dBμV/m]	Margin [dB]
1 004	37.71	1.00	23.82	5.10	37.62	29.01	56.00	-26.99
1 800	33.93	1.00	25.61	7.21	36.49	30.26	56.00	-25.74
2 002	33.52	1.00	26.05	7.72	36.27	31.02	56.00	-24.98
2 342	34.74	1.00	27.04	8.47	36.25	34.00	56.00	-22.00

* Results [dBμV/m] = Reading [dBμV] + Antenna Factor [dB/m] + Cable Loss [dB] – Amp. Gain [dB]

* Margin [dB] = Results [dBμV/m] – Limit [dBμV/m]

* At more than 6 G didn't test without noise

* **Field strength calculation**

Results [dBμV/m] = Reading [dBμV] + Antenna Factor [dB/m] + Cable Loss [dB] – Amp. Gain [dB]

Margin [dB] = Results [dBμV/m] – Limit [dBμV/m]

* **Measurement uncertainty**

Radiated emission electric field intensity, 30 MHz ~ 1 000 MHz: 3.3 dB

Radiated emission electric field intensity, above 1 GHz: 4.8 dB



4.2.6 Test graph Test data(above 1 GHz)

[Horizontal]

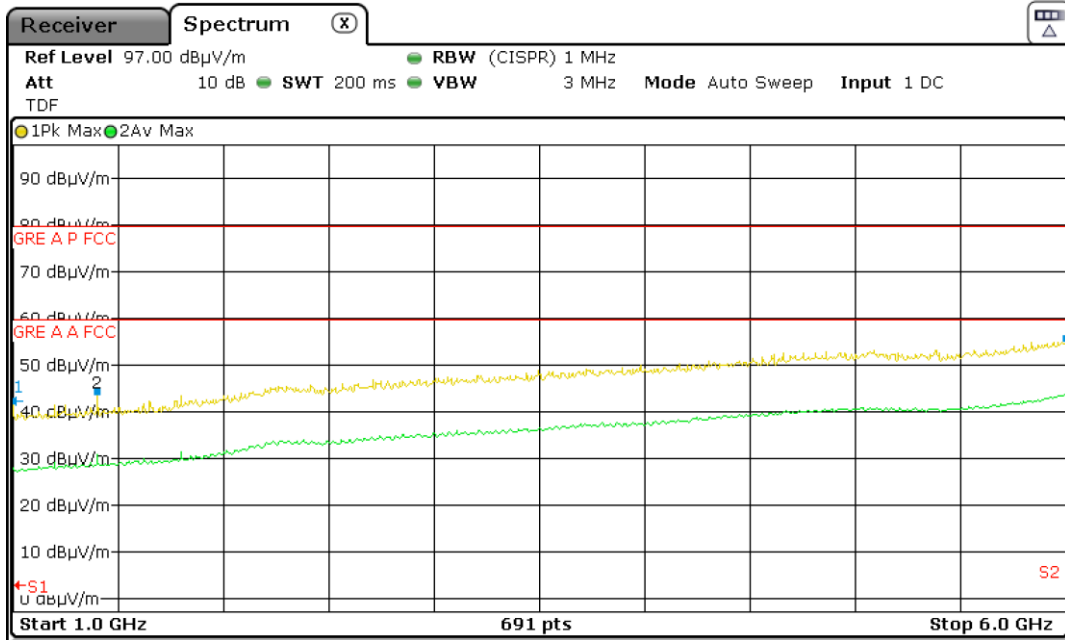

[Vertical]

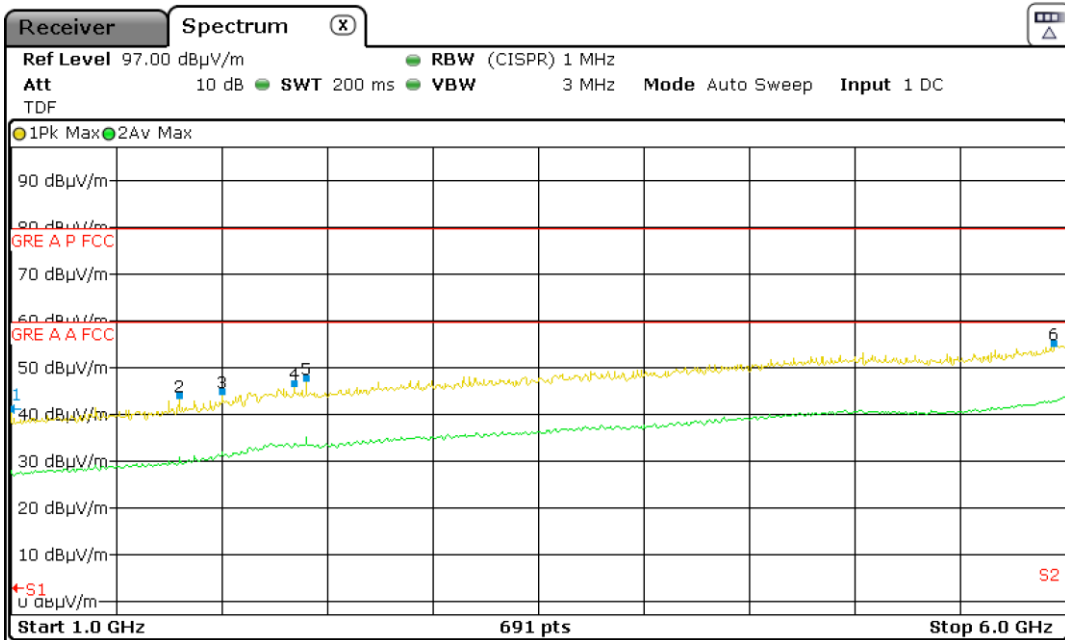

5. Appendix-A: Test Setup Photographs

5.1 Test Setup Photographs

5.1.1 Conducted emission

[Front view]

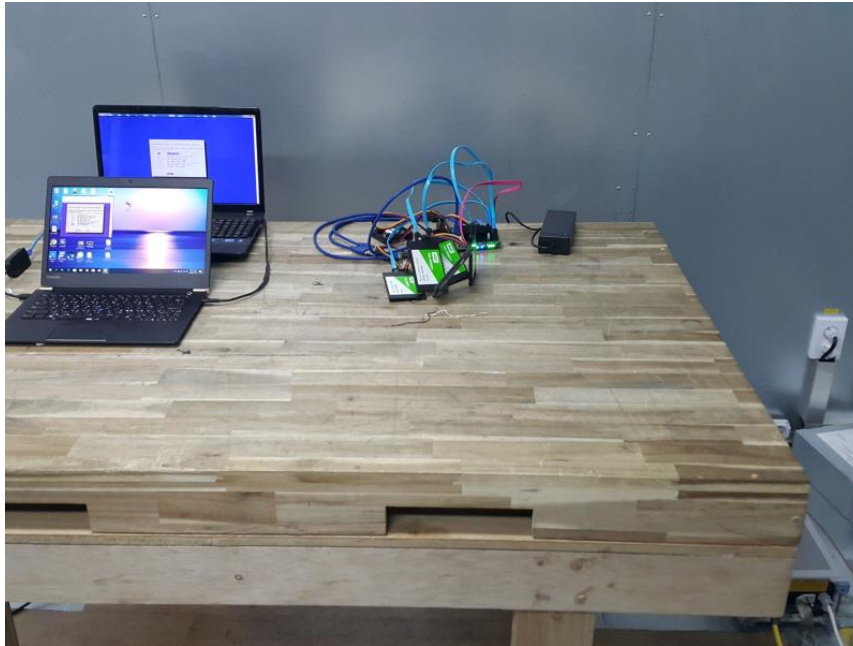

[Rear view]



5.1.2 Radiated emission (below 1 GHz)

[Front view]

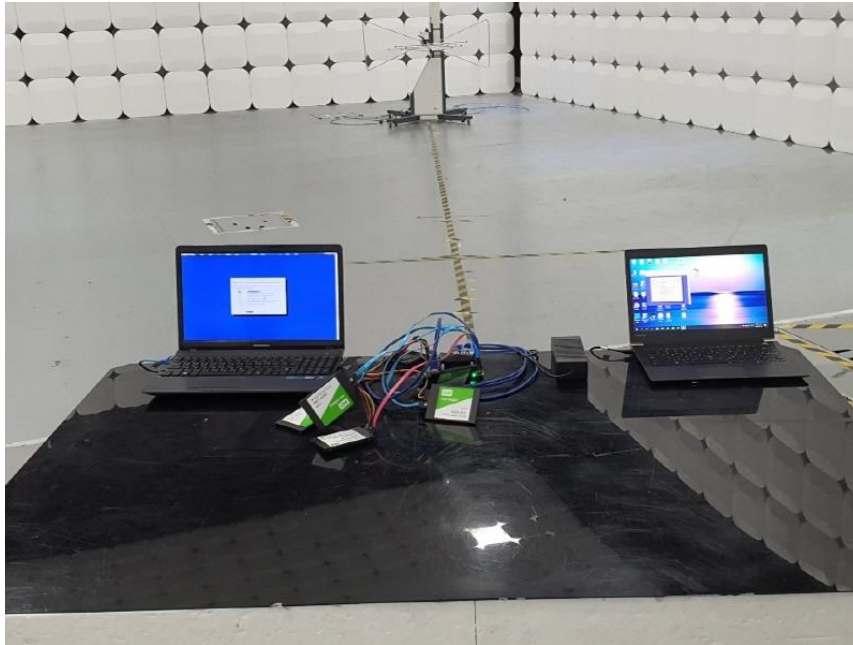

[Rear view]

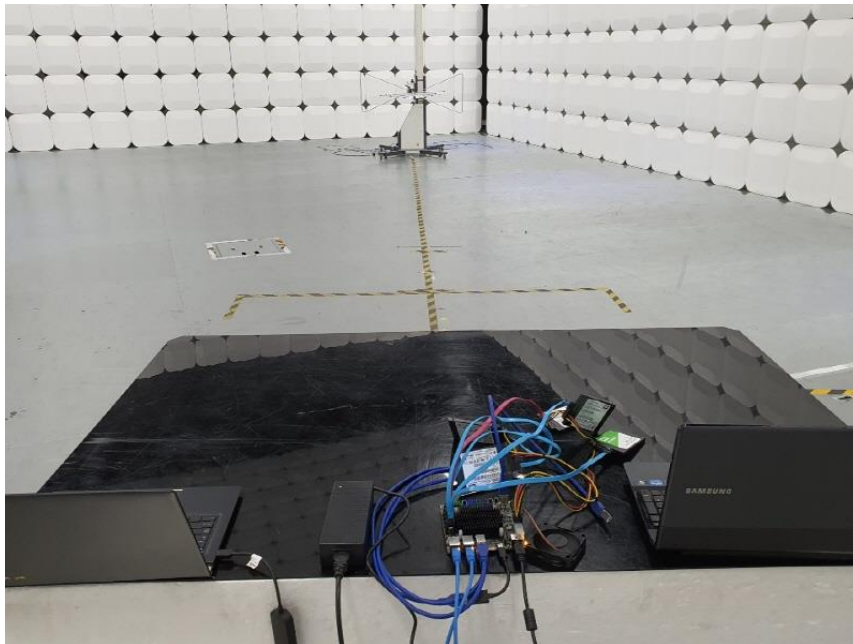

5.1.3 Radiated emission (above 1 GHz)

[Front view]

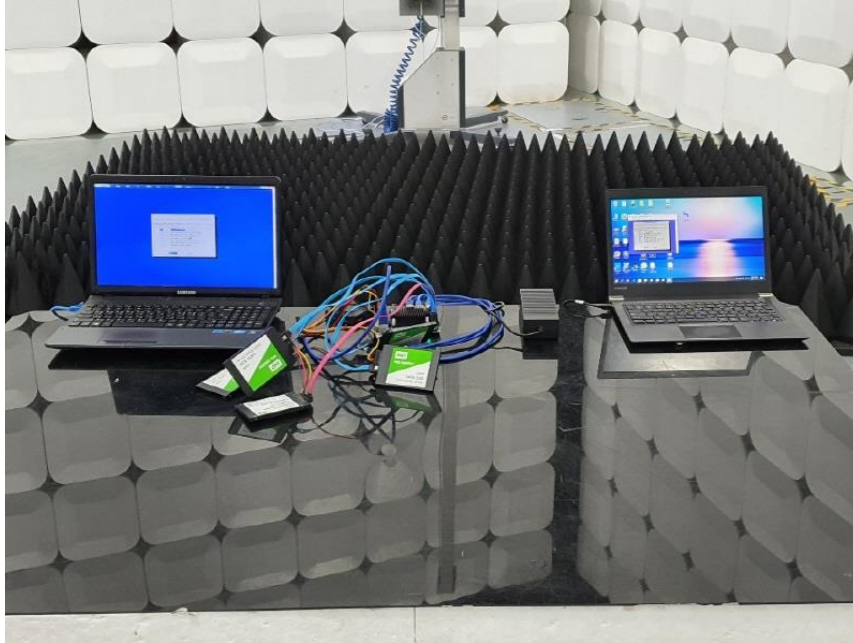

[Rear view]

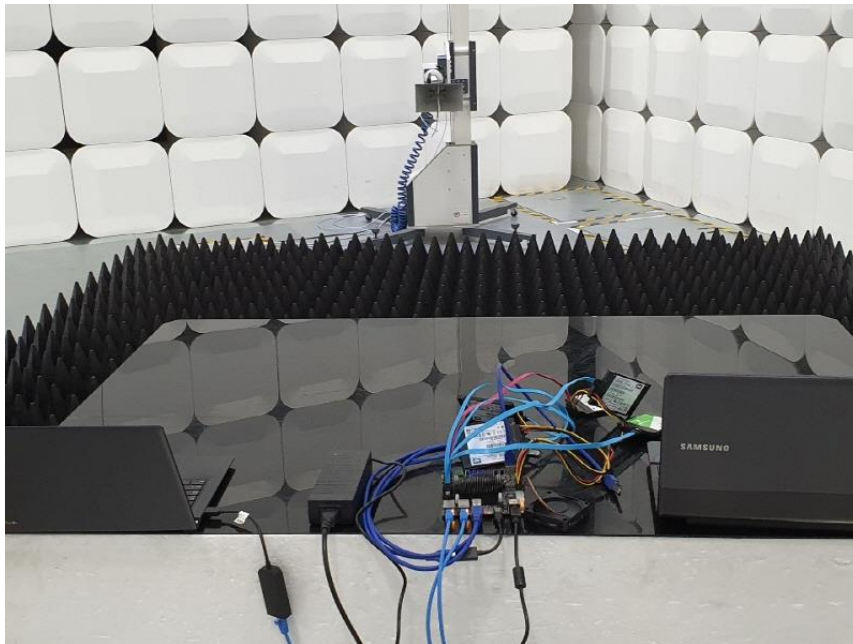



Manufacturer / Addition models

The following identical model(s): Helios64 – 4GB RAM

6. Appendix-D: Label and Manual information

(Proposed format to be included in the user's manual)

Supplier's Declaration of Conformity (SDoC)

Product Name	: Single Board Computer
Model Name	: Helios64
FCC Rules	: Tested to comply with FCC PART 15 SUBPART B
Operating Environment	: FOR OFFICE USE

FCC COMPLIANCE STATEMENT:

This device complies with part 15 of the FCC Rules. Operation is subject to the following two conditions: (1) this device may not cause harmful interference, and (2) this device must accept any interference received, including interference that may cause undesired operation.

INFORMATION TO USER:

This equipment has been tested and found to comply with the limits for a Class B digital device, pursuant to part 15 of the FCC Rules. These limits are designed to provide reasonable protection against harmful interference when the equipment is operated in a commercial environment. This equipment generates, uses, and can radiate radio frequency energy and, if not installed and used in accordance with the instruction manual, may cause harmful interference to radio communications. Operation of this equipment in a residential area is likely to cause harmful interference in which case the user will be required to correct the interference at his own expense.

This equipment has been tested and found to comply with the limits for a Class B digital device, pursuant to part 15 of the FCC Rules. These limits are designed to provide reasonable protection against harmful interference in a residential installation. This equipment generates uses and can radiate radio frequency energy and, if not installed and used in accordance with the instructions, may cause harmful interference to radio communications. However, there is no guarantee that interference will not occur in a particular installation.

If this equipment does cause harmful interference to radio or television reception, which can be determined by turning the equipment off and on, the user is encouraged to try to correct the interference by one more of the following measures:

- . Reorient or relocate the receiving antenna.
- . Increase the separation between the equipment and receiver.
- . Connect the equipment into an outlet on a circuit different from that to which the receiver is connected.
- . Consult the dealer or an experienced radio/TV technician for help.

CAUTION:

Any changes or modifications not expressly approved by the manufacturer responsible for compliance could void the user's authority to operate the equipment

THE PARTY RESPONSIBLE FOR PRODUCT COMPLIANCE

(YOUR CORPORATE NAME)

(STREET, CITY, STATE, USA)

(TELEPHONE NO: (XXX) YYY-ZZZZ)

(ABOVE NAME AND ADDRESS MUST BE LOCATED WITHIN THE UNITED STATES)

DECLARATION OF CONFORMITY LABELLING REQUIREMENTS

The labelling requirements for a device subject to the DoC procedure are specified in Section 15.19(b). The label should include the FCC logo along with the Trade Name and Model Number, which satisfies the unique identifier requirement of Section 2.1074 if it represents the identical equipment tested for DoC compliance.

§15.19(b)(1)(i) Products subject to authorization under a Declaration of Conformity shall be labelled as follows:

When the device is so small or for such use that it is not practicable to place the statement specified under paragraph 15.19(b)(1) on it, such as for a CPU board or a plug-in circuit board peripheral device, the text associated with the logo may be placed in a prominent location in the instruction manual or pamphlet supplied to the user.

However, the unique identification (trade name and model number) and the logo must be displayed on the device.

The label shall not be a stick-on, paper label. The label on these products shall be permanently affixed to the product and shall be readily visible to the purchaser at the time of purchase. "Permanently affixed" means that the label is etched, engraved, stamped, silkscreened, indelibly printed or otherwise permanently marked on a permanent attached part of the equipment or on a nameplate of metal, plastic, or other material fastened to the equipment by welding, riveting or a permanent adhesive.

The label must be designed to last the expected lifetime of the equipment in the environment in which the equipment may be operated and must not be readily detachable.